

**TECNOINOX**<sup>®</sup>

COLLECTION  
BOOK

2021-2022

COMPLEMENTI PER CUCINE



## LA NOSTRA STORIA/ OUR HISTORY



Fondata nel 1979, **TECNOINOX** ha festeggiato nel 2019 i primi 40 anni di attività. Nasce principalmente come produttore di scolapiatti specializzata nelle lavorazioni inox.

Nel tempo evolve il suo catalogo prodotti allargando la propria produzione con pattumiere, accessori interni per cassetti, progetti speciali customizzati ed ampliando le proprie competenze nell'utilizzo e nella lavorazione di diversi materiali come alluminio, profilati, plastica e legno.

La maggior parte dei prodotti viene sviluppata dal nostro ufficio tecnico interno, che si avvale anche dell'aiuto di professionisti esterni specializzati in Industrial Design. Vengono anche realizzati progetti customizzati in collaborazione diretta con i clienti.

Negli anni abbiamo investito molto nella tecnologia produttiva. Consideriamo che sia fondamentale per garantire la corretta qualità, produttività ed efficienza. Per noi non è solo importante quello che produciamo ma come lo facciamo.

Tutti i nostri prodotti sono progettati, lavorati ed assemblati nei nostri stabilimenti di Barlassina, nel mezzo del distretto produttivo del mobile della Brianza. Anche la maggior parte dei nostri fornitori sono Italiani, perché riteniamo che una stretta collaborazione e la giusta vicinanza ai fornitori possa portare a grandi risultati.

*Founded in 1979, TECNOINOX celebrated in 2019 the first 40 years of activity. Born mainly as a producer of dish drainer specializing in stainless steel processing.*

*Over time its product catalogue evolves expanding its production with dustbins, internal accessories for drawers, special customized projects and expanding their skills in the use and in the processing of different materials such as aluminium, profiles, plastic and wood.*

*Most of the products are developed by our in-house technical department, which also uses the help of specialized external professionals in Industrial Design. Customized projects are also realized in direct collaboration with customers.*

*Over the years we have invested a lot in production technology. We consider that it is fundamental to ensure the correct quality, productivity and efficiency. For us it is not only important that we produce but how we do it.*

*All our products are designed, processed and assembled in our factories of Barlassina, in the middle of the district furniture production in Brianza. Most of our suppliers are also Italians, because we believe that close cooperation and the right proximity to suppliers can lead to great results.*



**SCOLAPIATTI**  
*DRAINING BOARDS*

01



**PATTUMIERE DA INCASSO**  
*WASTE BINS*

11



**PATTUMIERE PER CASSETTO**  
*WASTE BINS FOR DRAWER*

25



**SOTTOVASCA**  
*UNDER SINK*

47



**ATTREZZATURE INTERNE  
PER CASSETTI**  
*INNER EQUIPMENTS FOR DRAWERS*

55



**LINEA ACCESSORI BAGNO**  
*BATHROOM ACCESSORIES*

91



**ACCESSORI**  
*ACCESSORIES*

97

## SCOLAPIATTI/ DRAINING BOARDS

INOXMATIC	04
INOXMATIC ICE	
INOXMATIC CUBE	
MODULAR 1	05
MODULAR 1 ICE	
MODULAR 1 CUBE	
MODULAR 2	06
INOXMATIC PER MOBILE AD ANGOLO	07
<i>INOXMATIC FOR CORNER UNITS</i>	
ESTRAIBILE	
ARCO ICE	
TELAIO PER MOBILE SCOLAPIATTI	08
<i>FRAME FOR DISH-RACK CABINET</i>	
TELAIO CON GOLA PER MOBILE SCOLAPIATTI	
<i>SHAPED FRAME FOR DISH-RACK CABINET</i>	
GRUPPO BARRA LED CON ALIMENTATORE PER TELAIO MOBILE SCOLAPIATTI	
<i>LED LIGHTING SET WITH POWER SUPPLY FOR DISH-RACK CABINET FRAME</i>	
TELAIO CON GOLA LED PER MOBILE SCOLAPIATTI	09
<i>FRAME WITH BUILT-IN LED LIGHTING FOR DISH-RACK CABINET</i>	
TELAIO CON GOLA REGOLABILE PER MOBILE SCOLAPIATTI	
<i>ADJUSTABLE SHAPED FRAME FOR DISH-RACK CABINET</i>	
TELAIO CON GOLA LED REGOLABILE PER MOBILE SCOLAPIATTI	
<i>ADJUSTABLE FRAME WITH BUILT-IN LED LIGHTING FOR DISH-RACK CABINET</i>	
TECHNICAL INFO	10



INOXMATIC ICE

## INOXMATIC

Inoxmatic è il classico scolapiatti Tecnoinox. Elegante, robusto, funzionale. Semplice e veloce da installare, bello da vedere, ora nella nuova versione Crystal Black.

- Massima resistenza alle flessioni a pieno carico;
- Eccezionale stabilità dei piatti;
- Certificazione contatto con alimenti.

Realizzato in acciaio inox AISI 304, Inoxmatic è disponibile nelle misure per pensile da \*40 a \*120 cm di larghezza e tre differenti tipologie di fissaggio: con spinotti a molla per foratura fianco Ø5, Ø10 mm e con ghiera regolabili.

*Inoxmatic is the Classic Tecnoinox draining board. Classy, resilient and functional. It is easily fitted and looks great, now with the new crystal Black look.*

- full load dish-rack bending resistance;
- exceptional dish stability;
- food contact certification;

*Made of AISI 304 stainless steel, Inoxmatic is available as a wall unit width from \*40 to \*120 cm and three different types of fixing: Ø5, Ø10 mm retractable pins for side boring and adjustable ring nuts.*



INOXMATIC 90 - VASCHETTA INOXMATIC - INOXMATIC TRAY

## INOXMATIC ICE

Inoxmatic Ice, con nuovo look Crystal Black, si distingue per la particolare vaschetta raccogliacqua a tenuta ermetica.

Il design del frontale rende il prodotto elegante e moderno, mentre le crociere all'interno della vasca favoriscono una migliore distribuzione del liquido ed una migliore maneggevolezza per l'estrazione e lo svuotamento dell'acqua.

La vaschetta Ice è interamente rivestita in acciaio inox AISI 304. Inoxmatic Ice è disponibile nelle misure per pensile da \*45, \*60, \*80 e \*90 cm. di larghezza e tre differenti tipologie di fissaggio: con spinotti a molla per foratura fianco Ø5, Ø10 mm e con ghiera regolabili.

*Inoxmatic Ice, draining board is characterized by the special watertight drip tray and from the new Crystal Black look.*

*The front profile design makes the overall view modern and elegant, while the inner cross buckets aid for a better distribution of liquids, for the handling and for the emptying of the drip tray.*

*The Ice drip tray is fully covered with stainless steel AISI 304. Inoxmatic Ice is available as a wall unit of \*45, \*60, \*80 and \*90 cm width and three different types of fixing: Ø5, Ø10 mm retractable pins for side boring and adjustable ring nuts.*



INOXMATIC 90 - VASCHETTA INOXMATIC ICE - INOXMATIC ICE TRAY

## INOXMATIC CUBE

Inoxmatic Cube, con nuovo look Crystal Black, si distingue per la particolare vaschetta raccogliacqua a tenuta ermetica.

Il design del frontale rende il prodotto elegante e moderno, mentre le crociere all'interno della vasca favoriscono una migliore distribuzione del liquido. La vaschetta Cube, leggera e trasparente, facilita l'estrazione e lo svuotamento dell'acqua. Inoxmatic Cube è disponibile nelle misure per pensile da \*45, \*60, \*80 e \*90 cm. di larghezza e tre differenti tipologie di fissaggio: con spinotti a molla per foratura fianco Ø5, Ø10 mm e con ghiera regolabili.

*Inoxmatic Cube draining board is characterized by the special watertight drip tray and from the new Crystal Black look.*

*The front profile design, makes the overall view modern and elegant, while the inner cross buckets aid for a better distribution of liquids. The Cube drip tray, is light and transparent, easy to extract and empty the water. Inoxmatic Cube is available as a wall unit of \*45, \*60, \*80 and \*90 cm width and three different types of fixing: Ø5, Ø10 mm retractable pins for side boring and adjustable ring nuts.*



INOXMATIC CUBE 90 - VASCHETTA INOXMATIC CUBE - INOXMATIC CUBE TRAY

## MODULAR 1

MODULAR 1 - VASCHETTA MODULAR 1 - MODULAR TRAY

Da un'idea totalmente innovativa, nasce la serie **Modular 1**, uno scolapiatti in acciaio inox AISI 304 che utilizza supporti plastici in materiale trasparente, ora nel nuovo colore Crystal Black, che possono essere spostati a piacimento sulla griglia e agganciati con una semplice pressione. La forma particolare e gli accessori forniti, permettono di riporre in modo stabile e sicuro, piatti, bicchieri, posate e pentole. Questo modello è particolarmente indicato per l'utilizzo nei pensili ad altezza ridotta (min. 32 cm), dove può trovare posto un'unica griglia attrezzata. I componenti sono prodotti in materiale atossico per alimenti e lavabili in lavastoviglie. Modular 1 è disponibile nelle larghezze da \*45 a \*120 cm. e tre differenti tipologie di fissaggio: con spinotti a molla per foratura fianco Ø5, Ø10 mm e con ghiera regolabili.

*Modular 1 series comes from a totally innovative idea, an AISI 304 stainless steel draining board with supports in clear plastic, now in the new Crystal Black look, that can be easily adjusted and snapped onto the grid. The special shape and the range of accessories supplied enable the stable and safe storage of kitchenware. This model is particularly suitable for use in wall cabinets with reduced height (min 32 cm) where a single grid can be accommodated with full accessories. The plastic parts are made of atoxic material and can be put in dishwasher. Modular 1 is available from \*45 to \*120 cm width and three different types of fixing: Ø5, Ø10 mm retractable pins for side boring and adjustable ring nuts.*



## MODULAR 1 ICE

MODULAR 1 ICE 90 - VASCHETTA MODULAR ICE - MODULAR ICE TRAY

**Modular 1 Ice**, con nuovo look Crystal Black, si distingue per la particolare vaschetta raccogliacqua a tenuta ermetica. Il design del frontale rende il prodotto elegante e moderno, mentre le crociere all'interno della vasca favoriscono una migliore distribuzione del liquido ed una migliore maneggevolezza per l'estrazione e lo svuotamento dell'acqua. La vaschetta Ice è interamente rivestita in acciaio inox AISI 304. Modular 1 Ice è disponibile nelle misure per pensile da \*45, \*60, \*80 e \*90 cm di larghezza e tre differenti tipologie di fissaggio: con spinotti a molla per foratura fianco Ø5, Ø10 mm e con ghiera regolabili.

*Modular 1 Ice draining board is characterized by the special watertight drip tray and from the new Crystal Black look. The front profile design makes the overall view modern and elegant, while the inner cross buckets aid for a better distribution of liquids, for the handling, and for the emptying of the drip tray. The Ice drip tray is fully covered with stainless steel AISI 304. Modular 1 Ice is available as a wall unit of \*45, \*60, \*80 and \*90 cm width and three different types of fixing Ø5, Ø10 mm retractable pins for side boring and adjustable ring nuts.*



## MODULAR 1 CUBE

MODULAR 1 CUBE 90 - VASCHETTA MODULAR CUBE - MODULAR CUBE TRAY

**Modular 1 Cube**, con nuovo look Crystal Black, si distingue per la particolare vaschetta raccogliacqua a tenuta ermetica. Il design del frontale rende il prodotto elegante e moderno, mentre le crociere all'interno della vasca favoriscono una migliore distribuzione del liquido. La vaschetta Cube, leggera e trasparente, facilita l'estrazione e lo svuotamento dell'acqua. Modular 1 Cube è disponibile nelle misure per pensile da \*45, \*60, \*80 e \*90 cm di larghezza e tre differenti tipologie di fissaggio: con spinotti a molla per foratura fianco Ø5, Ø10 mm e con ghiera regolabili.

*Modular 1 Cube draining board is characterized by the special watertight drip tray and from the new Crystal Black look. The front profile design, makes the overall view modern and elegant, while the inner cross buckets aid for a better distribution of liquids. The cube drip tray, is light and transparent, easy to handle and to empty. Modular 1 Cube is available in sizes for wall units of \*45, \*60, \*80 and \*90 cm width and three different types of fixing: Ø5, Ø10 mm retractable pins for side boring and adjustable ring nuts.*



MODULAR 1 ICE

## MODULAR 2

MODULAR 2 90 - VASCHETTA MODULAR - MODULAR TRAY

Da un'idea totalmente innovativa, nasce la serie **Modular 2**, uno scolapiatti in acciaio inox AISI 304 che utilizza supporti plastici in materiale trasparente, ora nel nuovo colore Crystal Black, che possono essere spostati a piacimento sulla griglia e agganciati con una semplice pressione. La forma particolare e gli accessori forniti permettono di riporre in modo stabile e sicuro piatti, bicchieri, posate e pentole. I componenti sono prodotti in materiale atossico per alimenti e lavabili in lavastoviglie. Modular 2 è disponibile nelle larghezze da \*45 a \*90 cm. e tre differenti tipologie di fissaggio: con spinotti a molla per foratura fianco Ø5, Ø10 mm e con ghiera regolabili.

*Modular 2 series comes from a totally innovative idea, an AISI 304 stainless steel draining board with supports in clear plastic, now in the new Crystal Black look, that can be easily adjusted and snapped onto the grid. The special shape and the range of accessories supplied enable the stable and safe storage of kitchenware. The plastic parts are made of atoxic material and can be put in dishwasher. Modular 2 is available from \*45 to \*90 cm width and three different types of fixing: Ø5, Ø10 mm retractable pins for side boring and adjustable ring nuts.*



## INOXMATIC PER MOBILE AD ANGOLO

INOXMATIC PER MOBILE AD ANGOLO 60 - INOXMATIC FOR CORNER UNITS

Inoxmatic è disponibile anche nella versione per il mobile ad angolo. Viene fornito completo di telaio e montante posteriore necessario per il montaggio del pensile. Viene realizzato su misura del cliente. Inoxmatic per mobile ad angolo, inoltre, è disponibile nella misura standard del mobile 60x60 cm.

*Inoxmatic is also available in the corner cabinet version. It is supplied complete with frame and rear upright necessary for the assembly of the cabinet. It is custom-made for the customer. Inoxmatic for corner cabinet is also available in the standard size of the cabinet 60x60 cm.*



## ESTRAIBILE

ESTRAIBILE

Scolapiatti estraibile per base ha la sua struttura interamente realizzata in acciaio inox AISI 304, così come lo scolapiatti modello Inoxmatic che vi è montato, il quale assicura una grande stabilità dei piatti e grande capacità di carico. Estraibile lavora su guide a doppia estrazione ad elevato scorrimento con chiusura ammortizzata ed una portata massima di 30 kg.

*Estraibile dish drainer for base has its structure entirely made of AISI 304 stainless steel, as well as the Inoxmatic model dish drainer mounted on it, which ensures great stability of the dishes and great load capacity. Estraibile works on high sliding double-extension runners with soft closing and a maximum load capacity of 30 kg.*



## ARCO ICE

ARCO ICE 60

Lo scolapiatti Arco Ice con il nuovo look Crystal Black, si distingue per la particolare vaschetta raccogli-gocce a tenuta ermetica. Può essere utilizzato sul piano di lavoro oppure su mensole. Dalla forma gradevole ed ergonomica, si caratterizza per il fianco in sandwich acciaio/polycarbonato trasparente e per la presenza di portaposate e portapiattini. Arco Ice è realizzato interamente in acciaio inox AISI 304. E' disponibile nelle misure da \*45, \*60 e \*90 cm di larghezza.

*Arco Ice dish rack with the new Crystal Black look, stands out for its special hermetically sealed drip tray. It can be used on the worktop or on shelves. It features steel and clear polycarbonate sides and separate cutlery stands and dish racks. Arco Ice is made entirely of AISI 304 stainless steel. It is available in sizes \*45, \*60 and \*90 cm width.*



## TELAIO PER MOBILE SCOLAPIATTI

TELAIO PER MOBILE SCOLAPIATTI - FRAME FOR DISH-RACK CABINET

Realizzato in alluminio anodizzato, è disponibile nelle misure per mobile da \*40 a \*120 cm di larghezza. Viene prodotto su disegno foratura fianco del cliente.

*Made of anodized aluminium, it is available for cabinet sizes from \*40 to \*120 cm wide. It is produced on the customer's side drilling drawing.*



## TELAIO CON GOLA PER MOBILE SCOLAPIATTI

TELAIO CON GOLA PER MOBILE SCOLAPIATTI - SHAPED FRAME FOR DISH-RACK CABINET

Realizzato in alluminio anodizzato, ha il profilo anteriore scaricato per poter facilitare l'apertura delle ante senza maniglia. Disponibile nelle misure per mobile da \*40 a \*120 cm di larghezza. Viene prodotto su disegno foratura fianco del cliente.

*Made of anodized aluminium, the front profile is unloaded to facilitate the opening of the doors without handle. Available in cabinet sizes from \*40 to \*120 cm wide. It is produced on the customer's side drilling drawing.*

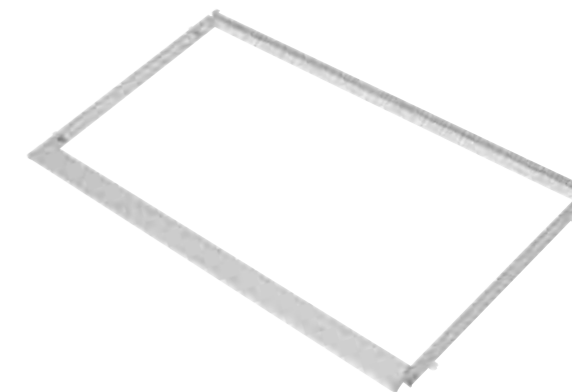

## GRUPPO BARRA LED CON ALIMENTATORE PER TELAI MOBILE SCOLAPIATTI

GRUPPO BARRA LED CON ALIMENTATORE  
LED LIGHTING SET WITH POWER SUPPLY

Set opzionale di illuminazione a led. Grazie alle frizioni a molla può essere installato in qualsiasi momento sul telaio del pensile scolapiatti Tecnoinox. E' costituito da una barra a led "Dual Color" 3000/4000°k, luce calda/luce naturale, certificata IP43, completa di profili copri cavo e alimentatore. E' disponibile nelle larghezze \*45, \*60, \*80, \*90 e \*120 cm.

*Optional LED lighting set for free installation on Tecnoinox dish-rack cabinet frame. It is equipped with a "Dual Color" 3000/4000°k led bar, warm light/natural light, IP43 protection, complete with cable cover profiles and power supply. It is available in \*45, \*60, \*80, \*90 and \*120 cm widths.*





## TELAIO CON GOLA LED PER MOBILE SCOLAPIATTI

Realizzato in alluminio anodizzato, viene prodotto su disegno foratura fianco del cliente. La barra led Dual Color 3000/4000°k luce calda/luce naturale è integrata nel profilo anteriore del telaio, certificata IP43, ed è completa di profili copricavo e alimentatore. E' disponibile nelle larghezze \*45, \*60, \*80, \*90 e \*120 cm.

*Made of anodised aluminium, it is produced on the customer's side drilling drawing. The Dual Color 3000/4000°k led bar warm light/natural light is integrated in the front profile of the frame, IP43 certified and is complete with cable cover profiles and power supply unit. It is available in \*45, \*60, \*80, \*90 and \*120 cm widths.*



TELAIO CON GOLA LED PER MOBILI SCOLAPIATTI  
SHAPED LED FRAME FOR DISH-RACK CABINET

## TELAIO CON GOLA REGOLABILE PER MOBILE SCOLAPIATTI

Realizzato in alluminio anodizzato, ha il profilo anteriore scaricato per poter facilitare l'apertura delle ante senza maniglia. Disponibile nelle larghezze per mobile da \*40 a \*120 cm. Di semplice installazione e regolabile in profondità con range di utilizzo da min. 300mm a max 350mm.

*Made of anodised aluminium, it has a shaped front profile to simplify the opening of the doors without handle. Available in cabinet widths from \*40 to \*120 cm. Easy to install and adjustable in depth with a range of use from min. 300mm to max. 350mm.*



TELAIO CON GOLA REGOLABILE PER MOBILI SCOLAPIATTI  
ADJUSTABLE SHAPED FRAME FOR DISH-RACK CABINET

## TELAIO CON GOLA LED REGOLABILE PER MOBILE SCOLAPIATTI

Realizzato in alluminio anodizzato, è di semplice installazione e regolabile in profondità con range di utilizzo da min. 300mm a max 350mm. La barra led Dual Color 3000/4000°k luce calda/luce naturale è integrata nel profilo anteriore del telaio, certificata IP43 ed è completa di profili copricavo e alimentatore. E' disponibile nelle larghezze da \*45, \*60, \*80, \*90 e \*120 cm.

*Made of anodized aluminium, it is easy to install and adjustable in depth with a range of use from min. 300mm to max 350mm. The Dual Color 3000/4000°k led bar warm light/natural light is integrated in the front profile of the frame, IP43 certified and is complete with cable cover profiles and power supply unit. It is available in \*45, \*60, \*80, \*90 and \*120 cm widths.*



TELAIO CON GOLA LED REGOLABILE PER MOBILI SCOLAPIATTI  
ADJUSTABLE LED SHAPED FRAME FOR DISH-RACK CABINET

## INOXMATIC INOXMATIC ICE - INOXMATIC CUBE

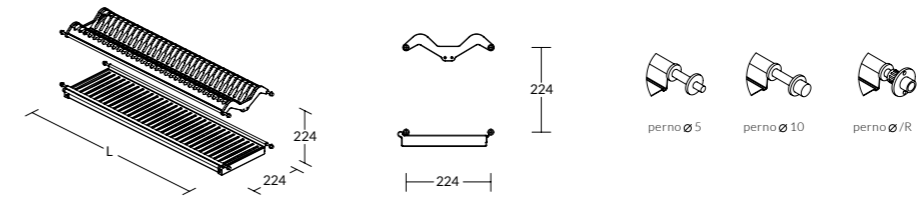

INOXMATIC  
L = da 400\* a 1200\* passo 50  
INOXMATIC ICE - CUBE  
L = 450\* - 600\* - 800\* - 900\*

## MODULAR 1 - MODULAR 1 ICE - MODULAR 1 CUBE

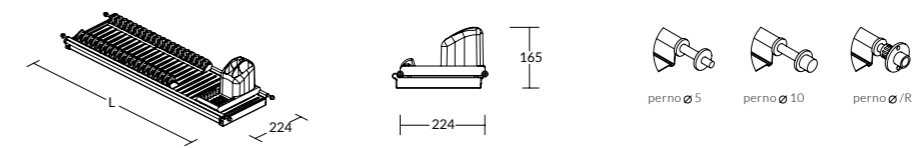

MODULAR 1  
L = da 400\* a 1200\* passo 50  
MODULAR 1 ICE-CUBE  
L = 450\* - 600\* - 800\* - 900\*

## MODULAR 2

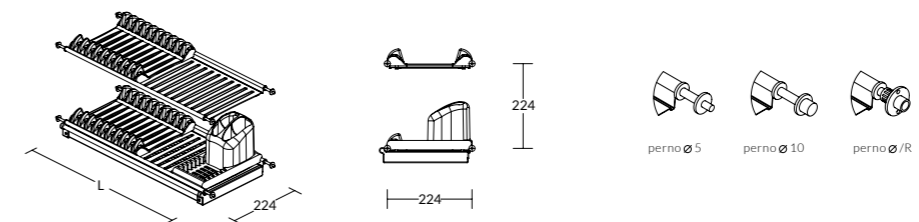

L = da 450\* a 900\* passo 50

## INOXMATIC PER MODULO AD ANGOLO

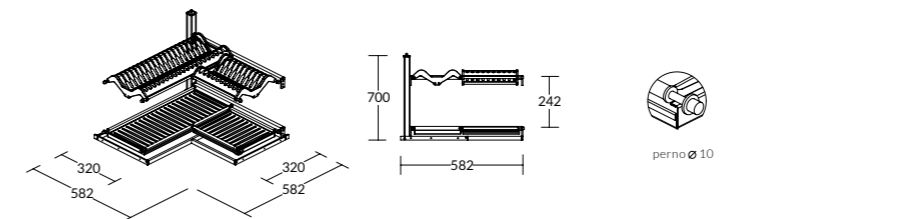

## ESTRAIBILE

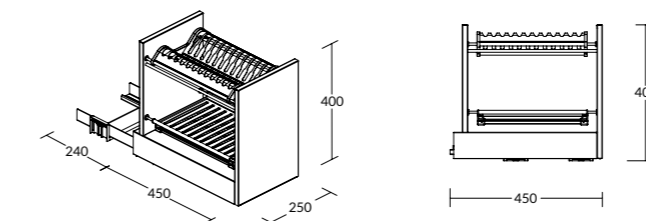

## ARCO ICE

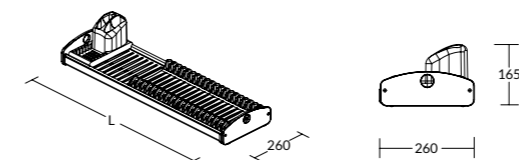

L = da 400\* 550\* 850\*

\* Le dimensioni si riferiscono alle misure nominali del cassetto. \* The dimensions refer to the nominal dimensions of the drawer.



## PATTUMIERE DA INCASSO/ WASTE BINS

---

SACCHETTI	13
BAGS	
PRIMA	15
SPAZIO	
BOX 1 - BOX 2	
BOX 3 - BOX 3.2	16
HIGHLINE 1 - HIGHLINE 2	18
HIGHLINE 3 - HIGHLINE 3.2	
BASE SYSTEM	19
BASE SYSTEM PLUS	22
TECHNICAL INFO	23

A completamento delle pattumiere Tecnoinox, abbiamo inserito all'interno della gamma accessori opzionali, nel rispetto delle norme ambientali e per praticità, la serie di sacchetti per la raccolta differenziata dei rifiuti:

acquistabili on-line sul sito [www.tecnoinox.it](http://www.tecnoinox.it)

*To complete the Tecnoinox bins, we have included the series of bags for the separate collection of waste within the range of optional accessories, in compliance with environmental standards and for practicality:*

*buy on-line at [www.tecnoinox.it](http://www.tecnoinox.it)*



- \*Sacchetto BIO "MATER-BI" per secchi da 8, 10 e 12 Lt  
venduto in scatole da 80 confezioni da 10 sacchetti.

\*Sacchetto rifiuti biodegradabili - compostabili secondo la norma UNI EN 13432

- *"BIO "MATER-BI" bucket bag for 8, 10 and 12 Lt buckets  
sold in boxes of 80 packs of 10 bags.*

*\*Biodegradable waste bag - compostable according to UNI EN 13432 standard*



- Sacchetto HD per secchi da 18 Lt.  
venduto in scatole da 40 confezioni da 10 sacchetti.

- *HD bag for 18 Lt.  
buckets sold in boxes of 40 packs of 10 bags.*



- Sacchetto HD per secchi da 25 Lt.  
venduto in scatole da 40 confezioni da 10 sacchetti.

- *HD bag for 25 Lt.  
buckets sold in boxes of 40 packs of 10 bags.*



CONFEZIONI SACCHETTI  
PACKS OF BAGS

## PRIMA

Modello di pattumiera ad incasso, scorrevole su pratiche guide fissate alla base del mobile, contiene un capiente secchio da 18 litri. Disponibile con carrozzeria in acciaio inox AISI 304 o alluminio verniciato poliestere.

*Built-in rubbish bin, sliding on practical runners fixed to the base of the cabinet, it contains an ample 18 litre container. Available with AISI 304 stainless steel or polyester painted aluminium body.*



## SPAZIO

La pattumiera Spazio è caratterizzata da un nuovo formato che si sviluppa in larghezza invece che in profondità, incrementando sensibilmente la comodità e la praticità. Con il minimo scorrimento in avanti, sollevandosi il coperchio, si ha la contemporanea accessibilità ai due secchi (10 lt. ciascuno) per la raccolta differenziata. La ridotta profondità e la facilità di sgancio agevolano l'installazione e rendono anche meno problematici eventuali interventi sulle utenze del sottolavello. Disponibile con carrozzeria in acciaio inox AISI 304 o alluminio verniciato poliestere.

*Spazio is a rubbish bin featuring a new format that develops widthwise instead of in depth, increasing convenience and practicality. With a slight forward shift, lifting the lid gives immediate access to two bins (10 lt. each) for separate waste disposal. The reduced depth and the simple unhooking movements make assembly and disassembly very simple in case it is necessary reaching the underparts of the sink. Available with AISI 304 stainless steel or polyester painted aluminium body.*



## BOX 1 - BOX 2

La serie Box rappresenta il top della gamma Tecnoinox nel campo della raccolta differenziata. Interamente carrozzata in acciaio inox AISI 304, la serie Box offre il grande vantaggio dell'ermeticità, essendo infatti completamente chiusa, evita la fuoriuscita di odori sgradevoli. I secchi scorrono su di un piano supportato da guide ad elevato scorrimento con chiusura ammortizzata. La parte superiore offre, inoltre, un comodo piano di appoggio dove poter riporre spugne, guanti, sacchetti, detersivi, ecc.

*The Box series stands at the top of the Tecnoinox range in the field of separate waste disposal. Entirely made in stainless steel AISI 304, the great advantage of the Box series is its airtightness, eliminating the problem of bad smells. The bins slide comfortably on runners fixed to the base and retract automatically. The bins slide on a plane supported by high sliding runners with soft closing. The upper part is also a practical work top, where sponges, gloves, bags and detergent can rest.*



## BOX 3 - BOX 3.2

La serie Box rappresenta il top della gamma Tecnoinox nel campo della raccolta differenziata. Interamente carrozzata in acciaio inox AISI 304, la serie Box offre il grande vantaggio dell'ermeticità, essendo infatti completamente chiusa, evita la fuoriuscita di odori sgradevoli. I secchi scorrono su di un piano supportato da guide ad elevato scorrimento con chiusura ammortizzata. La parte superiore offre, inoltre, un comodo piano di appoggio dove poter riporre spugne, guanti, sacchetti, detersivi, ecc.

*The Box series stands at the top of the Tecnoinox range in the field of separate waste disposal. Entirely made in stainless steel AISI 304, the great advantage of the Box series is its airtightness, eliminating the problem of bad smells. The bins slide comfortably on runners fixed to the base and retract automatically. The bins slide on a plane supported by high sliding runners with soft closing. The upper part is also a practical work top, where sponges, gloves, bags and detergent can rest.*



BOX 3





HIGHLINE 2

## X HIGHLINE 1 - HIGHLINE 2

Interamente carrozzata in acciaio AISI 304, la serie Highline offre il grande vantaggio dell'ermeticità, essendo infatti completamente chiusa, evita la fuoriuscita di odori sgradevoli. I secchi scorrono su di un carrello di nuova concezione, che garantisce una elevata stabilità. Il carrello è supportato da guide ad estrazione totale con chiusura ammortizzata testate e garantite fino a 60.000 cicli. La parte superiore offre inoltre un comodo piano di appoggio anch'esso rivestito in acciaio AISI 304 dove poter riporre spugne, guanti, sacchetti, detersivi ecc.

*Having its exterior housing entirely made of AISI 304 stainless steel, the Highline series offer a full tightness. In fact it is completely closed and for this reason it prevents bad smell emissions. The containers slide on a new concept carriage which guarantees high stability. The carriage is supported by fully extractable sliding guides which have a soft-closing device. The device has been tested and guaranteed for up to 60,000 opening cycles. The top part is made of AISI 304 stainless steel and can be used as a base where you can place sponges, gloves, plastic bags, detergents, etc.*



HIGHLINE 1



HIGHLINE 2



## X HIGHLINE 3 - HIGHLINE 3.2

Interamente carrozzata in acciaio AISI 304, la serie Highline offre il grande vantaggio dell'ermeticità, essendo infatti completamente chiusa, evita la fuoriuscita di odori sgradevoli. I secchi scorrono su di un carrello di nuova concezione, che garantisce una elevata stabilità. Il carrello è supportato da guide ad estrazione totale con chiusura ammortizzata testate e garantite fino a 60.000 cicli. La parte superiore offre inoltre un comodo piano di appoggio anch'esso rivestito in acciaio AISI 304 dove poter riporre spugne, guanti, sacchetti, detersivi ecc.

*Having its exterior housing entirely made of AISI 304 stainless steel, the Highline series offer a full tightness. In fact it is completely closed and for this reason it prevents bad smell emissions. The containers slide on a new concept carriage which guarantees high stability. The carriage is supported by full-extension runners with soft-closure, tested and guaranteed for up to 60,000 cycles. The top part is made of AISI 304 stainless steel and can be used as a base where you can place sponges, gloves, plastic bags, detergents, etc.*



HIGHLINE 3



HIGHLINE 3.2



## X BASE SYSTEM

Base System permette di organizzare in maniera completa ed efficiente tutti gli oggetti e i prodotti per la pulizia della casa normalmente contenuti nel sottolavello, così come gestire in modo efficiente la raccolta differenziata dei rifiuti. Gli elementi scorrevoli sono facilissimi e velocissimi da agganciare/sganciare, così da poter accedere con la massima semplicità alle utenze del sottolavello come rubinetti gas e acqua, scarichi lavello e lavastoviglie. Base System è interamente realizzato in alluminio verniciato nella finitura Titanio. E' disponibile per basi con anta battente da \*60, \*90 e \*120 cm di larghezza.

*Base System gives you the opportunity for complete, efficient organization of all those bits and pieces that usually pile up under your sink. It also makes the task of organising recyclable waste so much easier. The sliding parts are extremely quick and easy to use, so that you can get at any electrical or plumbing items in the back of the cupboard, should so require. Base System is made entirely in painted aluminium in Titanium finishing. It is available for base units with hinged door \*60, \*90 e \*120 cm width.*



BASE SYSTEM 60



BASE SYSTEM 90



BASE SYSTEM 120



BASE SYSTEM



BASE SYSTEM PLUS 120

## X BASE SYSTEM PLUS

Base System Plus coniuga eleganza, praticità e soprattutto grande capienza per gestire in modo efficiente la raccolta differenziata dei rifiuti e per organizzare al meglio, grazie allo spazioso ripiano superiore, spugne e detersivi. Gli elementi scorrevoli sono facilissimi e velocissimi da agganciare/sganciare, così da poter accedere con la massima semplicità alle utenze del sottolavello come rubinetti gas e acqua, scarichi lavello e lavastoviglie. Base System Plus è interamente realizzato in alluminio verniciato nella finitura Titanio. E' disponibile per basi con anta battente da \*60, \*90 e \*120 cm di larghezza.

*Base System Plus combines elegance, practicality and especially large capacity to efficiently manage the collection of waste, and to better organize, thanks to the large top shelf, sponges and detergents. The sliding parts are extremely quick and easy to use, so that you can get at any electrical or plumbing items in the back of the cupboard, should so require. Base System Plus is made entirely in painted aluminium in Titanium finishing. It is available for base units with hinged door \*60, \*90 e \*120 cm width.*



BASE SYSTEM PLUS 60



BASE SYSTEM PLUS 90



BASE SYSTEM PLUS 120



PRIMA 18 LT

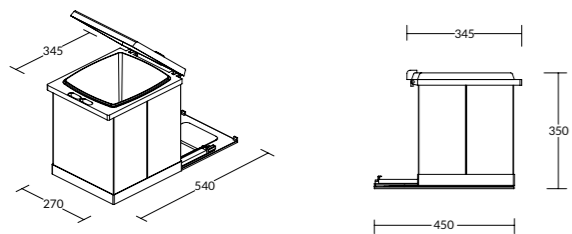

BOX 1 - BOX 2 21 LT

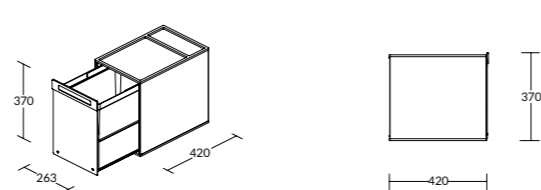

BASE SYSTEM PLUS 25 LT + 8 LT + 8 LT

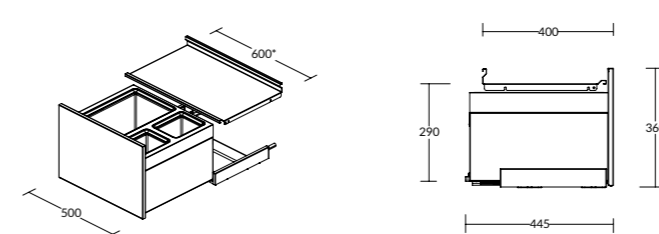

SPAZIO 10 LT + 10 LT

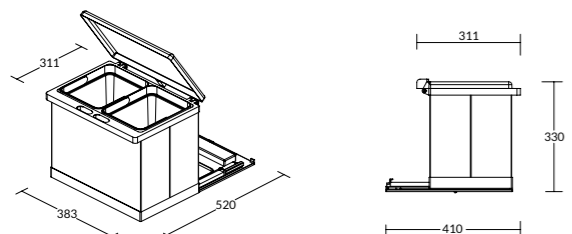

BOX 3 - BOX 3.2 10 LT + 10 LT

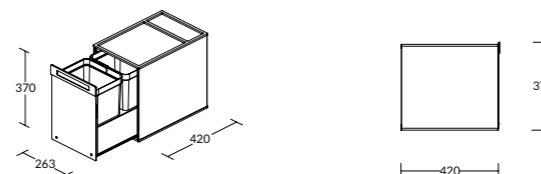

12 LT + 12 LT + 12 LT + 12 LT

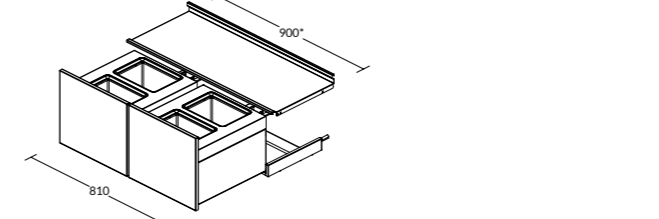

HIGHLINE 1 - HIGHLINE 2 21 LT

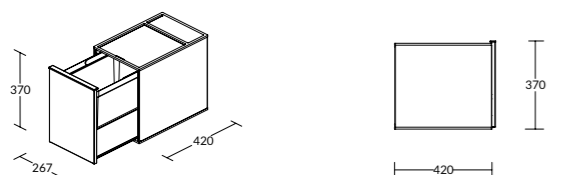

BOX 3 - BOX 3.2 10 LT + 10 LT + 16 LT

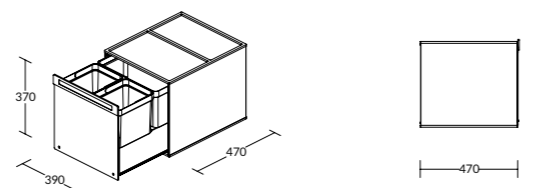

25 LT + 8 LT + 8 LT + 25 LT + 8 LT + 8 LT

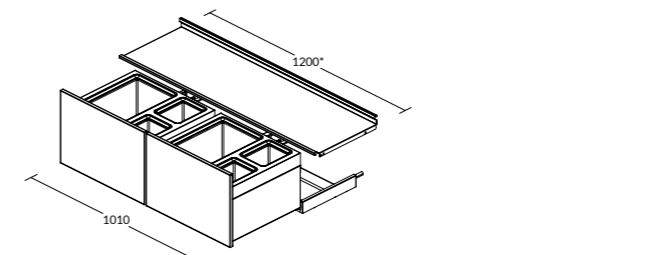

10 LT + 10 LT

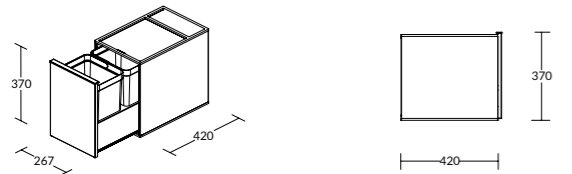

16 LT + 21 LT

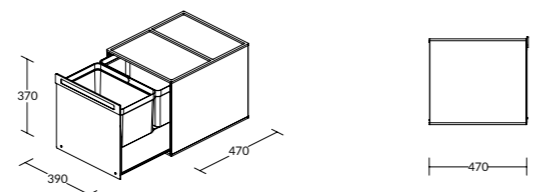

HIGHLINE 3 - HIGHLINE 3.2 10 LT + 10 LT + 16 LT

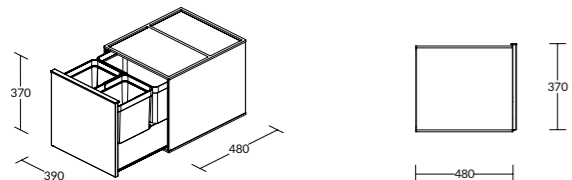

BASE SYSTEM 12 LT + 12 LT

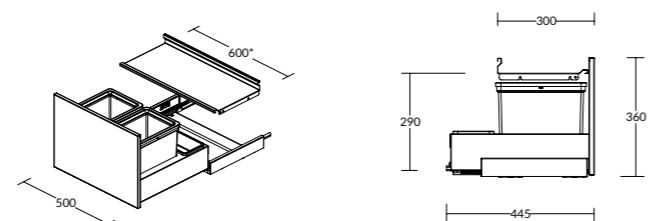

16 LT + 21 LT

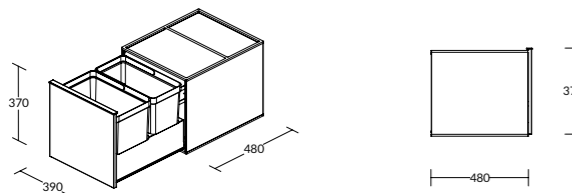

17 LT + 8 LT + 8 LT

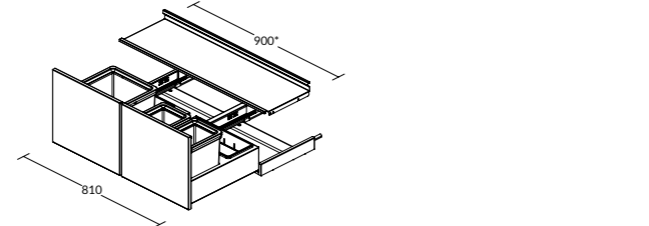

12 LT + 12 LT + 12 LT + 12 LT

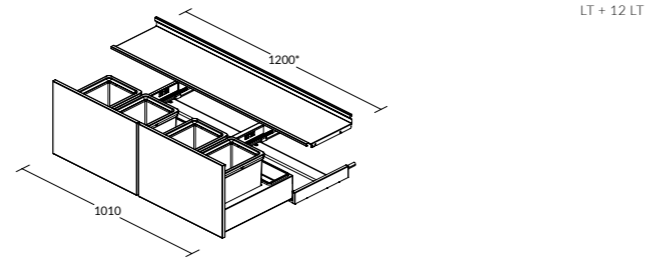

\* Le dimensioni si riferiscono alle misure nominali del cassetto. \* The dimensions refer to the nominal dimensions of the drawer.



## PATTUMIERE PER CASSETTO/ WASTE BINS FOR DRAWER

---

T3	28
T2	30
T2 REGOLABILE	
<i>T2 ADJUSTABLE</i>	
T2 AUTOMATIC	
TECNOBIG	31
TECNOBIG TRITARIFIUTI	
TECNOBIG ALLUMINIO	33
AL100	
K2	
TECNOKIT H22	36
KIT CASSETTO CON VASCHETTA	
<i>DRAWER KIT WITH TUBS</i>	
COMPENSATORI PROFONDITÀ	
<i>DEPTH COMPENSATOR</i>	
P-ONE	37
P-ONE KING SIZE	
P-ONE SOTTOLAVELLO	40
<i>P-ONE UNDER-SINK</i>	
P-ONE ECO SOTTOLAVELLO	
<i>P-ONE ECHO UNDER-SINK</i>	
TECHNICAL INFO	42



X T3

BIO  
8/12

25

Tecnoinox amplia nuovamente la propria gamma prodotti con T3. Dove funzionalità, capacità dei secchi ed estetica fanno la differenza. La base ed i coperchi sono realizzati in alluminio verniciato poliestere anti-impronta finitura Titanio. I coperchi, con filtro anti odore lavabile di serie, sono incernierati alla cornice premi sacchetto per secchi di capacità da 16Lt e 25Lt. La parte posteriore della base porta secchi, grazie ai sottili divisori in alluminio finitura Titanio, presenta degli scomparti dove poter riporre ordinatamente detersivi, capsule, spugne ecc. I secchi in plastica hanno altezza 26cm. La base è disponibile per cassetti da \*50cm di profondità e da \*60, \*75, \*90, \*105, \*120 cm di larghezza.



*Tecnoinox once again extends its product line with T3. Where functionality, bins capacity and aesthetics make the difference. The base and lids are made of polyester painted aluminium with Titanium finish. The lids, with washable anti-odour filter as standard, are hinged to the frame for 16 and 25 Lt bin capacity. The rear part of the base, thanks to the thin Titanium finish aluminium dividers, has compartments where detergents, capsules, sponges, etc. can be stored neatly. The plastic buckets are 26 cm high. The base is available for drawers \*50 cm deep and \*60, \*75, \*90, \*105, \*120 cm width.*

T3 90





T2 - 120

## X T2



Modello bestseller dei raccoglitori pattumiera, moderno ed elegante per organizzare lo spazio nel sottolavello. Di grande impatto estetico la base e i coperchi sono realizzati in alluminio verniciato poliester anti-impronta. I coperchi hanno il filtro antiodore lavabile di serie e sono incernierati sulla cornice premisacchetto. I secchi, di grandi dimensioni, sono compatibili con tutti i sacchetti in commercio. I secchi hanno altezza 26 cm. La base è disponibile nella finitura Titanio, Grigio Orione e Bianco per cassetti con \*50 cm di profondità e da \*60, \*75, \*90, \*105 e \*120 cm. di larghezza.

*Bestseller in the range of garbage collector, a modern and stylish way to organize the storage space under the kitchen sink. Quite stunning in design, the base and the lids are made of polyester painted aluminum anti-fingerprint. The lids have a washable odour filter as standard and are hinged to the premix frame. The bins of large size, are compatible with all bags on the market. The bins are 26 cm high. The base is available in Titanium, Orion Grey and White finish for drawers with \*50 cm depth and \*60, \*75, \*90, \*105 and \*120 cm width.*



## X T2 REGOLABILE



Con le stesse caratteristiche di T2 ma con l'esclusivo meccanismo incorporato nella base portasecchi che, su cassetti con profondità 472 mm, permette di compensare le differenze di fianco (da 16 a 22 mm di spessore) e di essere inserito in maniera indifferente su guide Blum Tandembox/Intivo/Antaro/Legrabox/Avant Tech You e Grass Vionaro. Di grande impatto estetico la base e i coperchi sono realizzati in alluminio verniciato poliester anti-impronta. I coperchi hanno il filtro antiodore lavabile di serie e sono incernierati sulla cornice premisacchetto. I secchi, di grandi dimensioni, sono compatibili con tutti i sacchetti in commercio. I secchi hanno altezza 26 cm. La base è disponibile nella finitura Titanio, Grigio Orione e Bianco per cassetti con \*50 cm di profondità e da \*60, \*90 e \*120 cm. di larghezza.

*Same characteristics as T2 but with the unique mechanism built into the base equipment which, out of 472 mm. deep drawers. It allows you to compensate for differences in side panels (from 16 to 22 mm thickness) and to be placed in indifferent runners like Blum Tandembox/ Intivo/Antaro/Legrabox/Avant Tech You and Grass Vionaro. Quite stunning in design, the base and the lids are made of polyester painted aluminum anti-fingerprint. The lids have a washable odour filter as standard and are hinged to the bag-retainer frame. The bins, of large size, are compatible with all bags on the market. The bins are 26 cm high. The base is available in Titanium, Orion Grey and White finish for drawers with \*50 cm depth and \*60, \*90 and \*120 cm width.*



## X T2 AUTOMATIC



T2 Automatic è il nuovo raccoglitore pattumiera, moderno ed elegante per organizzare lo spazio nel sottolavello. Il nuovo sistema esclusivo di apertura e chiusura automatico del coperchio, permette un utilizzo a "mani libere". La base portasecchi è realizzata in alluminio verniciato poliester anti-impronta. I secchi hanno altezza 26 cm. completi di cornice premisacchetto. La base è disponibile nella finitura Titanio per cassetti con \*50 cm di profondità e da \*60, \*90 e \*120 cm. di larghezza.

*T2 Automatic is the new garbage collector, a modern and stylish way to organize the storage space under the kitchen sink. The new exclusive automatic lid mechanism allow a hand free use. The base is made of polyester painted aluminum anti-fingerprints. The bins have a height of 26 cm. complete with bag-retainer frame. The base is available in Titanium finish for drawers with \*50 cm depth and \*60, \*90 and \*120 cm width.*





Tecnobig presenta linee pure ed essenziali. Massimo sfruttamento degli spazi ed enorme capacità di contenimento. Tecnobig ha la base e i coperchi realizzati in alluminio verniciato poliestere anti-impronta. I coperchi hanno filtro antiodore lavabile di serie e cornici premisacchetto. I secchi, in plastica hanno altezza 26 cm. La base è disponibile nella finitura Titanio e Grigio Orione per cassetti con \*50 cm di profondità e da \*60, \*75, \*90, \*105 e \*120 cm. di larghezza.

*Tecnobig presents pure and essential lines, maximum use of space, huge storage capacity. Tecnobig has the base and lids made of polyester painted aluminum anti-fingerprint. The lids have a standard washable anti-odour filter and a bag-retainer frame. The bins, in plastic, have a height of 26 cm. The base is available in Titanium and Grey Orion finish for drawers with \*50 cm depth and \*60, \*75, \*90, \*105 and \*120 cm width.*



Tecnobig Tritarifiuti, con le stesse caratteristiche di Tecnobig, ma con la posizione dei secchi studiata per evitare interferenze con il tritarifiuti che sia posizionato centralmente o lateralmente. Tecnobig Tritarifiuti ha la base e i coperchi realizzati in alluminio verniciato poliestere anti-impronta. I coperchi hanno filtro antiodore lavabile di serie e cornici premisacchetto. I secchi, in plastica, hanno altezza 26 cm. La base è disponibile nella finitura Titanio per cassetti con \*50 cm di profondità e da \*60, \*75, \*90, \*105 e \*120 cm. di larghezza.

*Tecnobig Waste Shredder, with the same characteristics as Tecnobig, but with the position of the bins designed to avoid interference with the Waste Shredder that is positioned centrally or laterally. Tecnobig Waste Shredder has the base and covers made of polyester painted aluminum anti-fingerprint. The lids have a standard washable anti-odour filter and press-frames. The bins, in plastic, are 26 cm high. The base is available in Titanium finish for drawers with \*50 cm depth and \*60, \*75, \*90, \*105 and \*120 cm width.*



## TECNOBIG ALLUMINIO



Tecnobig Alluminio è il nuovo Top di gamma Tecnoinox, presenta linee pure ed essenziali. Massimo sfruttamento degli spazi ed enorme capacità di contenimento. Tecnobig Alluminio ha la base, secchi e coperchi realizzati in alluminio verniciato poliestere anti-impronta. I coperchi hanno filtro antiodore lavabile di serie e cornici premisacchetto. I secchi, in alluminio, sono disponibili su richiesta e hanno altezza 30, 35 e 40 cm. La base è disponibile nella finitura Titanio per cassetti con \*50 cm di profondità e da \*60, \*75, \*90, \*105 e \*120 cm. di larghezza.

*Tecnobig Aluminium is the new Top of the range of Tecnoinox, presents pure and essential lines, maximum use of space, huge storage capacity. Tecnobig Aluminium has the base, bins and lids made of polyester painted aluminum anti-fingerprint. The lids have a standard washable anti-odour filter and a bag-retainer frame. The bins, in aluminium, are available on request and are 30, 35 and 40 cm high. The base is available in Titanium finish for drawers with \*50 cm depth and \*60, \*75, \*90, \*105 and \*120 cm width.*



## AL 100



100% alluminio. Riducendo al minimo indispensabile l'utilizzo di componenti plastiche, abbiamo realizzato AL100. Prodotto che si distingue per l'eleganza dei materiali e la praticità degli spazi.

Caratteristiche principali:

- Secchi, coperchi e base sono realizzati in alluminio verniciato poliestere anti-impronta;
- Secchi di grande capacità;
- Cornice premisacchetto;
- Filtro antiodore lavabile di serie per la frazione umida;

La base è disponibile nella finitura Titanio per cassetti con \*50 cm di profondità e da \*60, \*90 e \*120 cm. di larghezza.

*100% aluminium. Cutting down to the bare essential one's use of plastic components, we have devised AL 100. A product that stands out for its classy materials and practical use of available space.*

Main features:

- Bins, lids and base are made of polyester painted aluminum anti-fingerprint;
- Large capacity bins;
- Bag-retainer frame;
- Standard washable odour filter for wet fraction;

The base is available in Titanium finish for drawers with \*50 cm depth and \*60, \*90 and \*120 cm width.



## K2



K2 è la pratica proposta per l'organizzazione dello spazio sottolavello. La base portasecchi è realizzata in alluminio verniciato poliestere anti-impronta. I coperchi hanno il filtro antiodore lavabile di serie, completi di cornice premisacchetto. I secchi, di grandi dimensioni, sono compatibili con tutti i sacchetti in commercio. Nella parte posteriore trovano spazio gli ampi contenitori per bottiglie, flaconi ed altro materiale per la pulizia della casa. I secchi, in plastica, hanno altezza 26 cm. La base è disponibile nella finitura Titanio e Grigio Orione per cassetti con \*50 cm di profondità e da \*60, \*75, \*90, \*105 e \*120 cm. di larghezza.

*K2 is a practic solution for organizing the storage space under the kitchen sink. The base is made of polyester painted aluminum anti-fingerprint aluminum. The lids have a washable anti-odour filter as standard, complete with bag-retainer frame. The bins, of large size, are compatible with all bags on the market. The rear part features a large storage space for bottles, detergent flasks and other household cleaning materials. The bins, in plastic, are 26 cm high. The base is available in Titanium and Grey Orion finish for drawers with \*50 cm depth and \*60, \*75, \*90, \*105 and \*120 cm width.*



K2 - 120



KIT DA CASSETTO CON VASCHETTA  
DRAWER KIT WITH TUBS

## TECNOKIT H22



Di grande impatto estetico. Base e coperchi sono in alluminio verniciato anti-impronta. I coperchi, con filtro anti odore lavabile di serie, sono incernierati sulla cornice premisacchetto. I secchi, di grandi dimensioni, sono compatibili con tutti i sacchetti in commercio. Nella parte posteriore trovano spazio gli ampi contenitori per bottiglie, flaconi ed altro materiale per la pulizia della casa. I secchi, in plastica, hanno altezza 22 cm. La base è disponibile nella finitura Titanio e Grigio Orione per cassetti con \*50 cm di profondità e da \*60, \*90 e \*120 cm. di larghezza.

*Of great aesthetic impact. Base and lids are in anti-fingerprint painted aluminium, making it a compact, unique and stylish item. The lids, with washable anti-odour filter as standard, are hinged on the bag-retainer frame. The large bins are compatible with all bags on the market. In the rear part there is space for large containers for bottles, bottles and other household cleaning materials. The bins, in plastic, are 22 cm high. The base is available in Titanium and Grey Orion finish for drawers with \*50 cm depth and \*60, \*90 and \*120 cm width.*



## KIT DA CASSETTO CON VASCHETTA



Kit da Cassetto con Vaschetta, un grande classico Tecnoinox. Base in alluminio verniciato anti-impronta. I coperchi, con filtro anti odore lavabile di serie, sono incernierati sulla cornice premisacchetto. I secchi, di grandi dimensioni, sono compatibili con tutti i sacchetti in commercio. La parte posteriore è un perfetto e ampio spazio per riporre bottiglie, detersivi e altri materiali per la pulizia della casa. I secchi, in plastica, hanno altezza 26 cm. La base è disponibile nella finitura Titanio e Grigio Orione per cassetti con \*50 cm di profondità e da \*60, \*75, \*90, \*105 e \*120 cm. di larghezza.

*Kit da Cassetto con Vaschetta, a great Tecnoinox classic product. Base in polyester painted aluminum anti-fingerprint. The lids, with washable odour filter as standard, are hinged on the bag-retainer frame. The bins, large size, are compatible with all bags on the market. The back is a perfect and ample space for storing bottles, detergents and other household cleaning materials. The bins, in plastic, are 26 cm high. The base is available in Titanium and Grey Orion finish for drawers with \*50 cm depth and \*60, \*75, \*90, \*105 and \*120 cm width.*



## COMPENSATORE DI PROFONDITÀ

Il Compensatore di Profondità viene utilizzato all'interno dei cassetti con profondità \*60 cm. Può essere abbinato ai diversi modelli di pattumiera per cassetto. Il compensatore è disponibile nelle finiture Titanio e Grigio Orione per cassetti da \*60, \*75, \*90, \*105 e \*120 cm. di larghezza.

*The Depth Compensator is used inside the \*60 cm. deep drawers. It can be combined with different models of rubbish bin for drawers. The compensator is available in Titanium and Orion Grey finish for drawers with \*60, \*75, \*90, \*105 and \*120 cm. width.*





P - ONE

## X P-ONE

**P-one** è la soluzione proposta da Tecnoinox per una pattumiera da fissare direttamente sull'anta. Aprendo l'anta del mobile, grazie al meccanismo di apertura brevettato, viene alzato il coperchio di chiusura dei secchi ed è possibile accedere ai contenitori di grande capacità predisposti per la raccolta differenziata. Chiudendo l'anta, invece, il coperchio andrà ad adagiarsi sulla bocca dei secchi e la speciale guarnizione posta sotto il coperchio eviterà la fuoriuscita di eventuali odori sgradevoli. Caratteristiche principali del prodotto:

- Sistema esclusivo di chiusura dei secchi
  - Secchi realizzati in alluminio verniciato poliestere anti-impronta;
  - Volume di carico (da 54 a 108 litri);
  - Cornice premisacchetto;
  - Dimensioni dei secchi compatibili con sacchetti standard presenti sul mercato;
  - Sistema compatibile con tutte le principali tipologie di cassetto;
  - Estrema velocità e facilità di installazione e di regolazione;
  - Assenza di sbandamenti e flessioni dell'anta.
- Disponibile nella finitura Titanio e nelle misure da \*45 e \*60 cm di larghezza.

*P-One is the solution presented by Tecnoinox for a door-fitted dustbin. Thanks to the patented mechanism, opening the kitchen unit door deftly lifts the dustbin lid, ensuring easy access to the large containers for separated waste disposal. Shutting the door will close the lid flush with the bin rim, while the special gasket under the lid will seal any bad smells inside. Main product features:*

- Exclusive bins closing system;
- Bins made of polyester painted aluminum anti-fingerprint;
- Very large capacity range (from 54 to 108 litres);
- Bag-retainer frame;
- Bin sizes compatible with standard bags on the market;
- System compatible with all the main types of drawer;
- Speedy and problem-free installation and adjustment;
- No wobbling or warping of the door.

*It is available in Titanium finishes for drawers with \*45, \*60 cm width.*



## X P-ONE KING SIZE

**P-One King Size** è la soluzione proposta da Tecnoinox per una pattumiera da fissare direttamente sull'anta. Aprendo l'anta del mobile, grazie al meccanismo di apertura brevettato, viene alzato il coperchio di chiusura dei secchi ed è possibile accedere ai contenitori di grande capacità predisposti per la raccolta differenziata. Chiudendo l'anta, invece, il coperchio andrà ad adagiarsi sulla bocca dei secchi e la speciale guarnizione posta sotto il coperchio eviterà la fuoriuscita di eventuali odori sgradevoli. Caratteristiche principali del prodotto:

- Sistema esclusivo di chiusura dei secchi;
- Secchi realizzati in alluminio verniciato anti-impronta;
- Grande volume di carico (44+44 litri/90 litri);
- Dimensioni dei secchi compatibili con sacchetti standard presenti sul mercato;
- Sistema compatibile con tutte le principali tipologie di cassetto;
- Estrema velocità e facilità di installazione e di regolazione;
- Assenza di sbandamenti e flessioni dell'anta.

Disponibile nella finitura Titanio e nella misura da \*60 cm di larghezza.

*P-One King Size is the solution presented by Tecnoinox for a doorfitted dustbin. Thanks to the patented mechanism, opening the kitchen unit door deftly lifts the dustbin lid, ensuring easy access to the large containers for separated waste disposal. Shutting the door will close the lid flush with the bin rim, while the special gasket under the lid will seal any bad smells inside. Main product features:*

- Exclusive bins closing system;
- Bins made of polyester painted aluminum anti-fingerprint;
- Very large capacity range (44+44 liters and 90 liters);
- Bin sizes compatible with standard bags on the market;
- System compatible with all the main types of drawer;
- Speedy and problem-free installation and adjustment;
- No wobbling or warping of the door;

*It is available in Titanium painted finishes for drawers with \*60 cm width.*





P - ONE KING SIZE 1

PATTUMIERE PER CASSETTI / WASTE BINS FOR DRAWER



P - ONE KING SIZE 2

TECNOINOX

COLLECTION BOOK



## X P-ONE SOTTOLAVELLO



La famiglia di prodotti P-One si allarga con la realizzazione di questa variante adatta per l'utilizzo nella base lavello attrezzata con cestone estraibile ad anta intera. I secchi in alluminio verniciato poliestere anti-impronta con altezza 30 cm, permettono di utilizzare l'efficace meccanismo di apertura/chiusura automatica anche sotto alle vasche lavello della base da 60 cm così come la configurazione a 4 secchi garantisce un eccezionale sfruttamento degli spazi per una efficiente raccolta differenziata. Oltre a mantenere tutte le caratteristiche della gamma P-one, ha in aggiunta un coperchio supplementare con filtro anti odore per il secchio di raccolta della frazione umida e le cornici premisacchetto. E' disponibile nella finitura Titanio.



*P-One family is increased with this new under-sink version of the popular door fitted dustbin. The 30 cm high bins, made in polyester painted aluminium, permit the use of the exclusive lid opening/closing mechanism also in the undersink 60 cm wide base unit. The 4 bins configuration is perfect for a good waste management. The product keeps all the main features of the P-one family, with the addition of the extra lid with odor filter and the bag-retainers frame. It is available in Titanium finishes.*

## X P-ONE ECO SOTTOLAVELLO



La famiglia di prodotti P-One si allarga con la realizzazione di questa variante adatta per l'utilizzo nella base lavello attrezzata con cestone estraibile ad anta intera. I secchi in materiale plastico con altezza 26 cm permettono di utilizzare l'efficace meccanismo di apertura/chiusura automatica anche sotto alle vasche lavello della base da 60 cm, così come la configurazione a 4 secchi garantisce un eccezionale sfruttamento degli spazi per una efficiente raccolta differenziata. I secchi sono completi di cornice premisacchetto. E' disponibile nella finitura Titanio.



*P-One family is increased with this new under-sink version of the popular door fitted dustbin. The 26 cm high bins, made in polypropylene plastic, permit the use of the exclusive lid opening/closing mechanism also in the undersink 60 cm wide base unit. The 4 bins configuration is perfect for a good waste management. The product keeps all the main features of the P-one family, with the addition of the extra lid with odor filter. The bins are complete with bag-retainer frame. It is available in Titanium finishes.*



P-ONE ECO SOTTOLAVELLO  
P-ONE ECO UNDER SINK

T3

25 LT + 16 LT

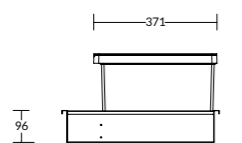
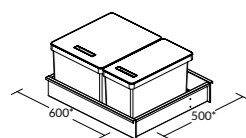

T2

12 LT + 17 LT

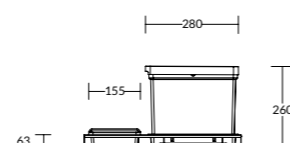
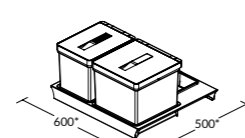

TECNOBIG

25 LT + 8 LT + 8 LT

TECNOBIG TRITARIFIUTI

8 LT + 8 LT

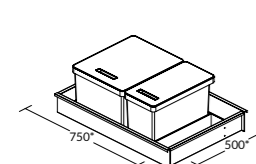
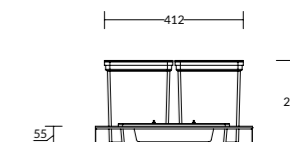
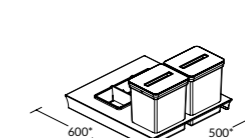
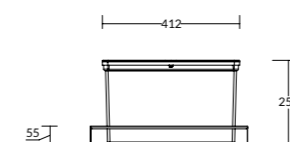
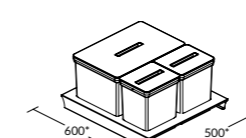

25 LT + 16 LT

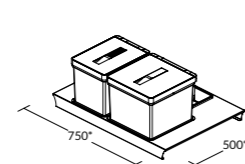

12 LT + 17 LT

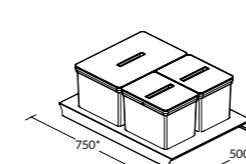

25 LT + 12 LT + 12 LT

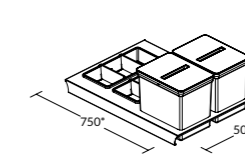

12 LT + 12 LT

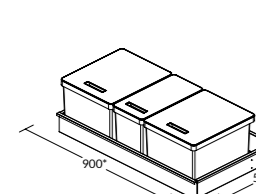

25 LT + 16 LT + 25 LT

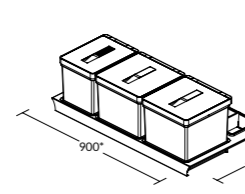

12 LT + 17 LT + 17 LT

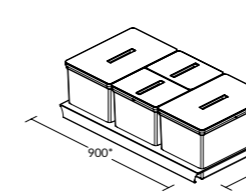

25 LT + 12 LT + 12 LT + 25 LT

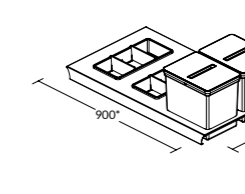

12 LT + 12 LT

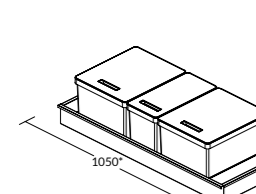

25 LT + 16 LT + 25 LT

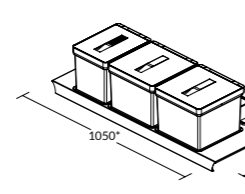

12 LT + 17 LT + 17 LT

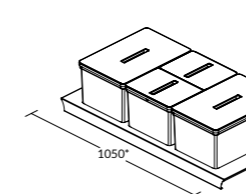

25 LT + 12 LT + 12 LT + 25 LT

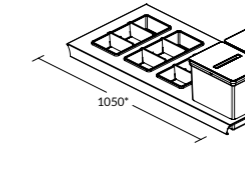

12 LT + 12 LT

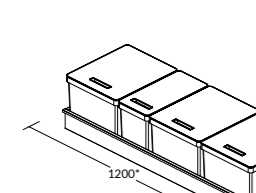

25 LT + 16 LT + 25 LT + 25 LT

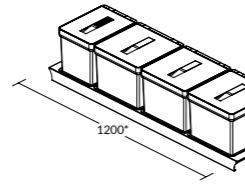

12 LT + 17 LT + 17 LT + 17 LT

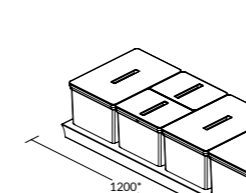

25 LT + 12 LT + 12 LT + 25 LT + 25 LT

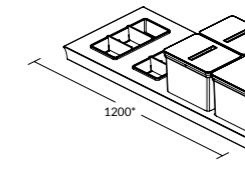

12 LT + 12 LT + 25 LT

T2 REGOLABILE

12 LT + 17 LT

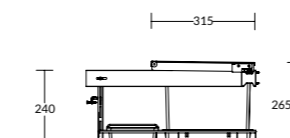
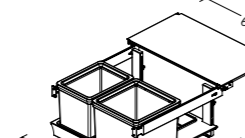
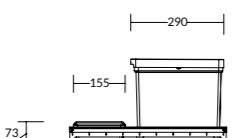
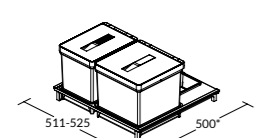

12 LT + 17 LT

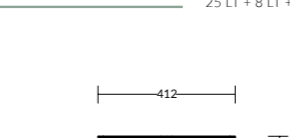

25 LT + 12 LT + 12 LT + 25 LT

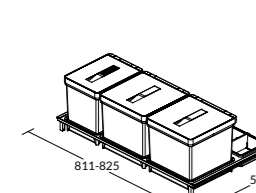

12 LT + 17 LT + 17 LT

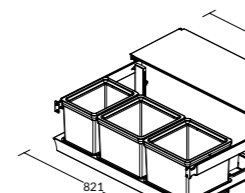

12 LT + 17 LT + 17 LT

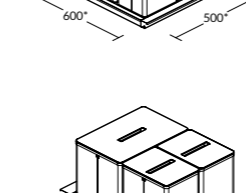

25 LT + 12 LT + 12 LT

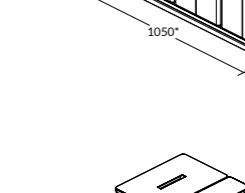

25 LT + 12 LT + 12 LT + 25 LT + 25 LT

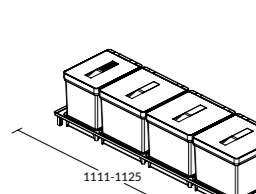

12 LT + 17 LT + 17 LT + 17 LT

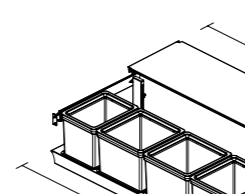

12 LT + 17 LT + 17 LT + 17 LT

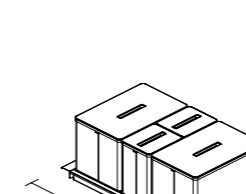

25 LT + 8 LT + 8 LT + 25 LT

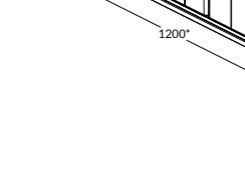

AL100

13 LT + 18 LT

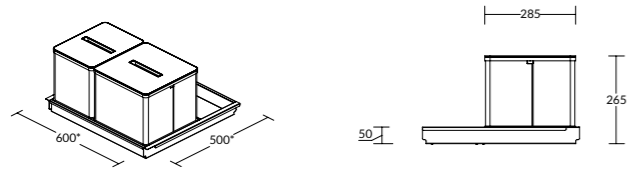

13 LT + 18 LT + 18 LT

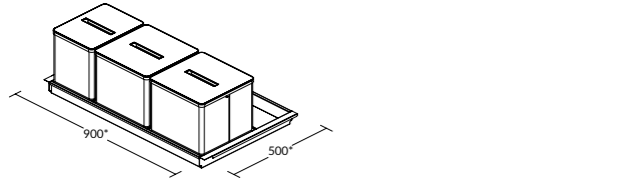

13 LT + 18 LT + 18 LT + 18 LT

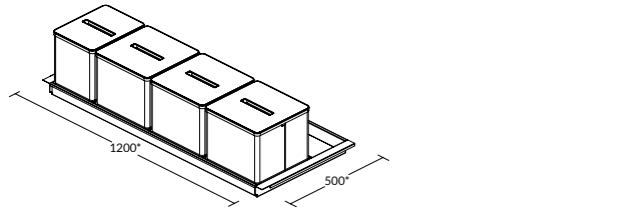

TECNOKIT H22

15 LT

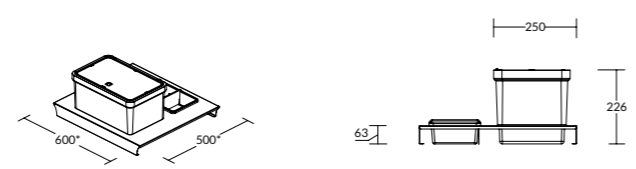

15 LT + 15 LT

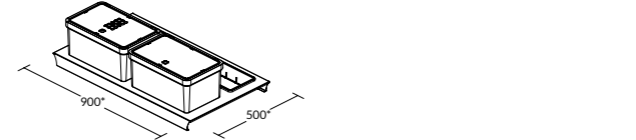

15 LT + 15 LT + 15 LT

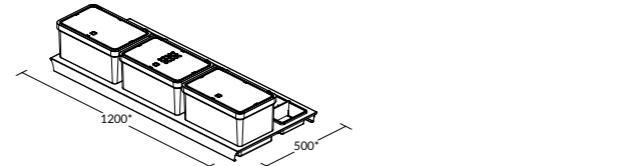

KIT CASSETTO CON VASCHETTA

12 LT + 8 LT

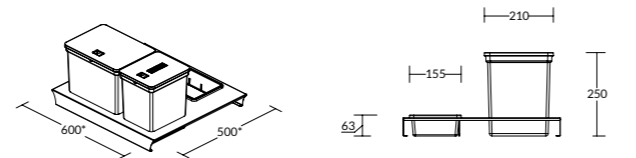

12 LT + 8 LT

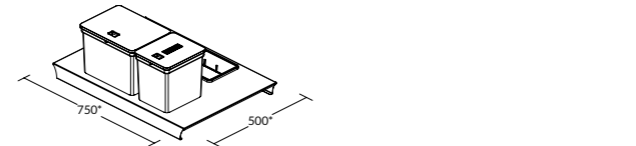

12 LT + 8 LT + 12 LT

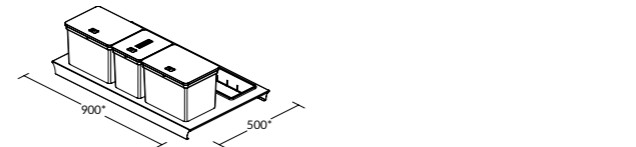

12 LT + 8 LT + 12 LT

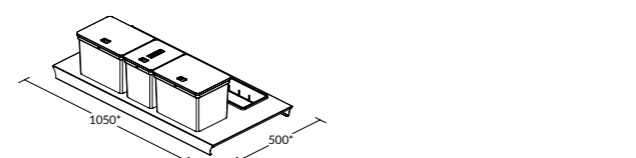

12 LT + 8 LT + 12 LT + 12 LT

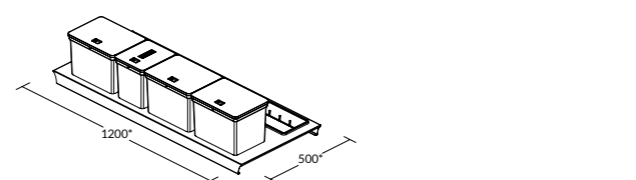

COMPENSATORE DI PROFONDITA'

L = 600\* 750\* 900\* 1050\* 1200\*

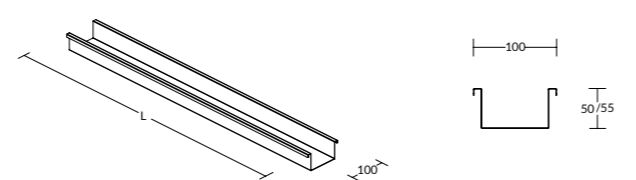

K2

12 LT + 17 LT

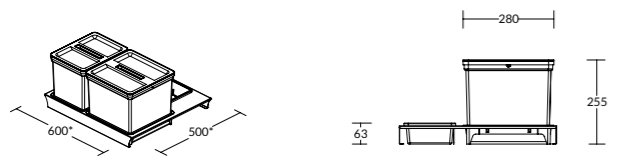

12 LT + 17 LT

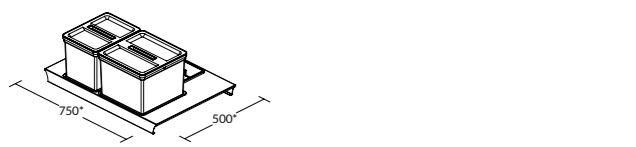

12 LT + 17 LT + 17 LT

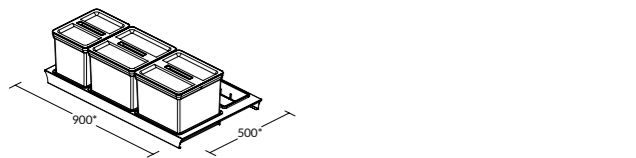

12 LT + 17 LT + 17 LT

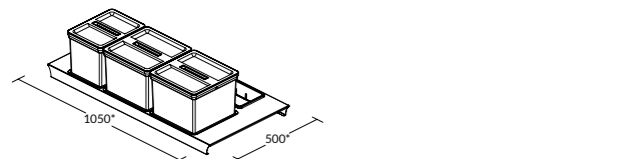

12 LT + 17 LT + 17 LT + 17 LT

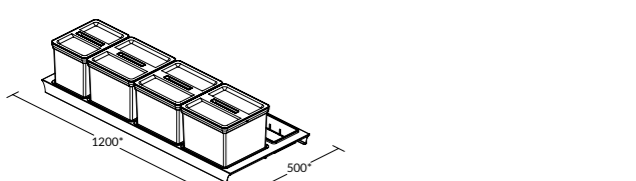

P-ONE

27 LT + 27 LT

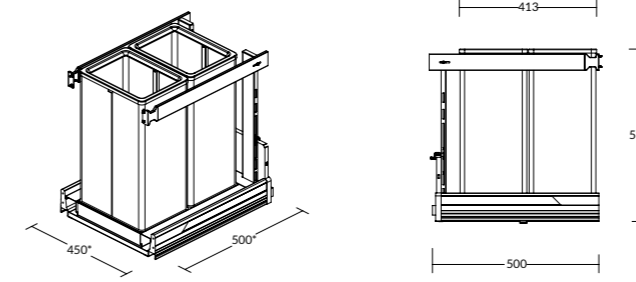

33 LT + 33 LT

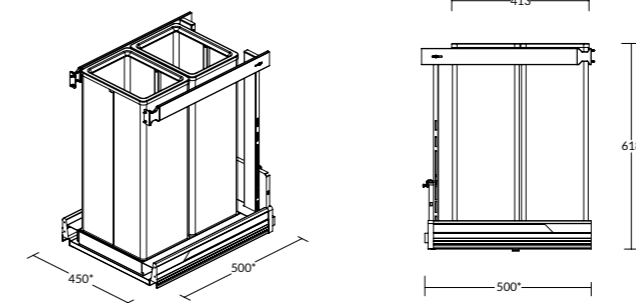

66 LT + 21 LT + 21 LT

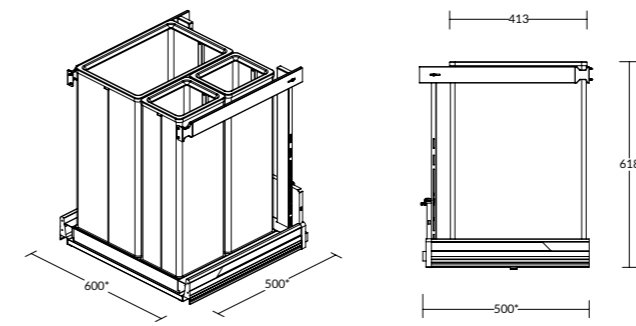

P-ONE KING SIZE

55 LT

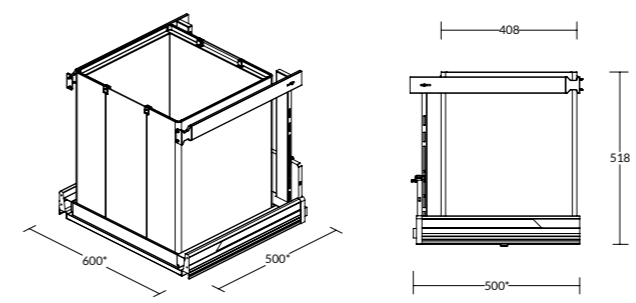

44 LT + 44 LT

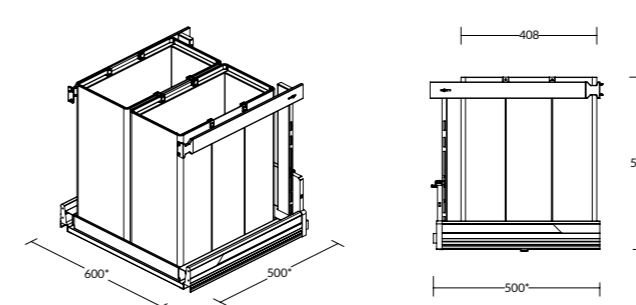

P-ONE SOTTOLAVELLO

16 LT + 16 LT + 10 LT + 10 LT

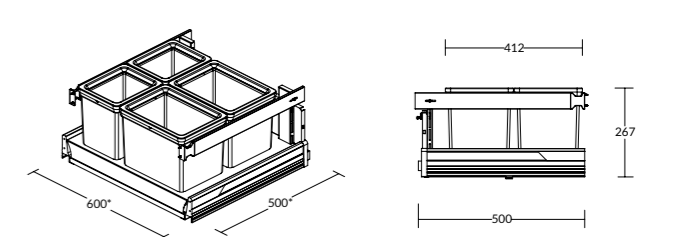

P-ONE ECO SOTTOLAVELLO

8 LT + 8 LT + 27 LT + 27 LT

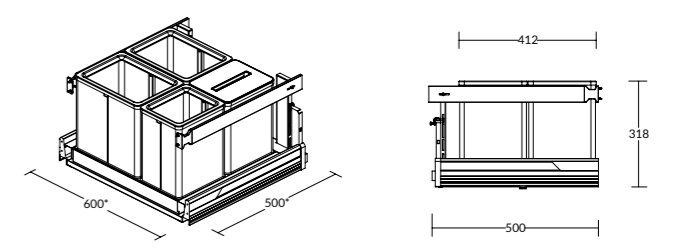



## SOTTOVASCA/ UNDERSINK

---

SOTTOVASCA P14	50
<i>UNDER-SINK P14</i>	
SOTTOVASCA FRONT 15	
<i>UNDER-SINK FRONT 15</i>	
VASCETTE PER SOTTOVASCA FRONT 15	52
<i>UNDER-SINK FRONT 15 TRAYS</i>	
TECHNICAL INFO	54



SOTTOVASCA P 14  
UNDER-SINK P14

## X SOTTOVASCA P14

L'accessorio sottovasca **All in P14** è realizzato in alluminio. Presenta una grande capacità di carico per lo sfruttamento dello spazio superiore del sottolavello, offrendo soprattutto una grande rigidità e solidità della struttura associata ad una estrema facilità di installazione. E' disponibile nelle seguenti finiture: verniciato Nero, Titanio, Grigio Orione e Bianco, per larghezze da \*60, \*75, \*90, \*105, \*120 cm e può essere facilmente adattato per qualsiasi fuori misura.

*Under-sink All-in P14 is completely made of aluminium, it offers a big loading capacity, big storage space, and an extremely strong and stiff structure. The very easy and quick mounting is associated to the adaptability with several drawer systems and brands. It is available in the following finishes: painted Black, Titanium, Orion Grey and White, for widths from \*60, \*75, \*90, \*105, \*120 cm and can be easily fitted to custom sizes.*



## X SOTTOVASCA FRONT 15

L'accessorio sottovasca **Front 15** è realizzato in alluminio. Presenta una grande capacità di carico per lo sfruttamento dello spazio superiore del sottolavello, ha una grande rigidità e solidità della struttura associata ad una estrema facilità di installazione. Nelle misure \*75, \*90, \*105 e \*120 cm è corredato di due vaschette in materiale plastico che possono essere liberamente agganciate sul profilo anteriore oppure inserite all'interno del canale. Front 15 è realizzabile per diverse tipologie di sponde cassetto in commercio. E' disponibile nelle seguenti finiture: verniciato Nero, Titanio, Grigio Orione e Bianco, per larghezze da \*60, \*75, \*90, \*105, \*120 cm e può essere facilmente adattato per qualsiasi fuori misura.

*Under-sink All-in Front 15 is completely made of aluminium, it offers a big loading capacity, big storage space, and an extremely strong and stiff structure. The very easy and quick mounting is associated to the adaptability with several drawer systems and brands. For drawers \*75, \*90, \*105 and \*120 cm width, is equipped with two plastic boxes that can be hooked on the front profile or place within the front channel. It is available in the following finishes: painted Black, Titanium, Orion Grey and White, for widths from \*60, \*75, \*90, \*105, \*120 cm and can be easily fitted to custom sizes.*





SOTTOVASCA FRONT 15 - 90 CON VASCHE  
 UNDER-SINK FRONT 15 - 90 WITH BOXES

**X** VASCHE OPZIONALI FRONT 15

I Contenitori opzionali per Front 15, possono essere utilizzati per aumentare la capacità di carico e massimizzare lo sfruttamento dello spazio intorno alle vasche del lavello. Realizzati in Plastica o Alluminio, sono solidi e capienti, dotati di sistema di aggancio anti scivolamento. Disponibili nelle misure 230 mm e 350 mm e nelle finiture alluminio verniciato Nero, Titanio, Grigio Orione. Versione in plastica nelle finiture Grigio Orione e Bianco.

*The Optional containers for Front 15, can be used to increase loading capacity and maximize the use of space around the sink tanks. Made of Plastic or Aluminium, they are solid and capacious, equipped with anti-slip hooking system. Available in sizes 230 mm and 350 mm and in aluminium painted Black, Titanium, Orion Grey. Plastic version in the finishes Orion Grey and White.*



\* Nelle immagini viene indicata una composizione tipo.  
 Le vaschette laterali sono elementi opzionali.

*\* A standard composition is shown in the pictures.  
 The side trays are optional elements.*



FRONT 15

SOTTOVASCA P14

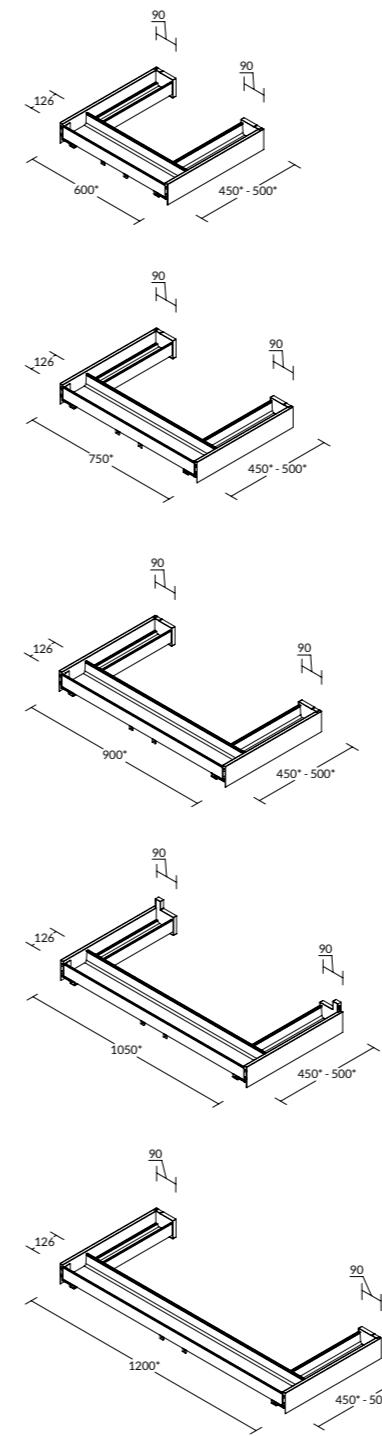

SOTTOVASCA FRONT 15

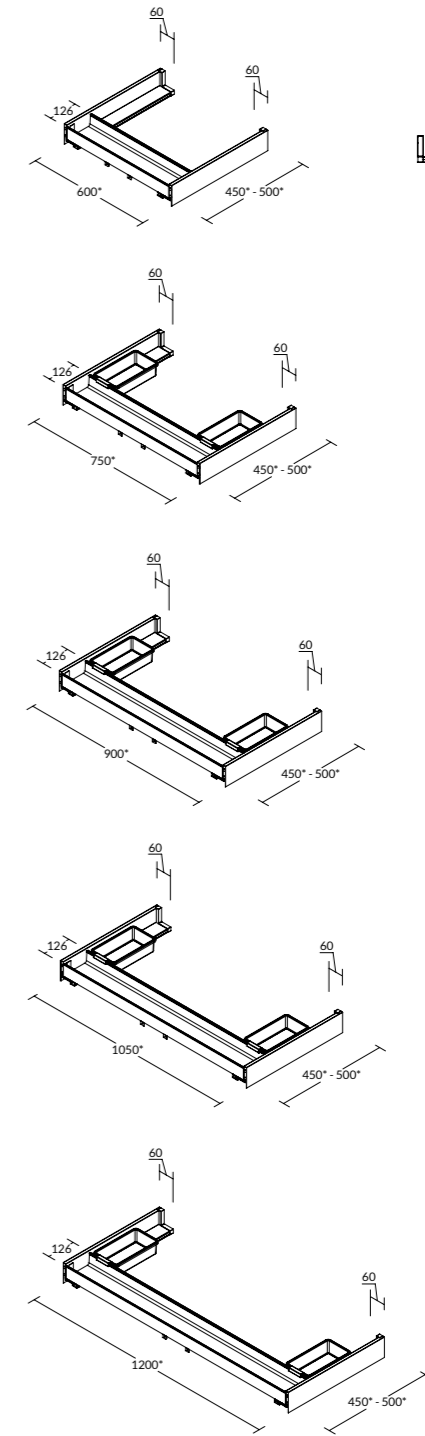

VASCHETTA OPZIONALI FRONT 15

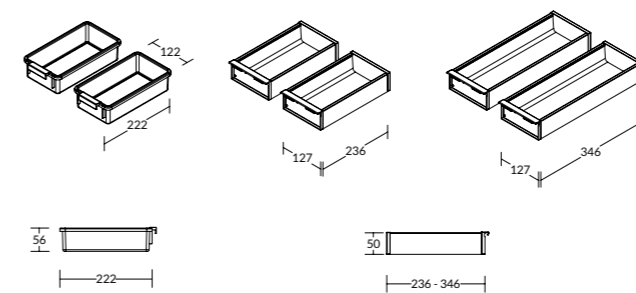

\* Le dimensioni si riferiscono alle misure nominali del cassetto. \* The dimensions refer to the nominal dimensions of the drawer.

## ATTREZZATURE INTERNE PER CASSETTI/ INNER EQUIPMENTS FOR DRAWERS

---

FIT	58
FIT PORTAPOSATE	59
<i>FIT CUTLERY INSERTS</i>	
FIT DISPENSA	
<i>FIT PULL OUT</i>	
FILO	61
FILO PORTAPOSATE	63
<i>FILO CUTLERY INSERTS</i>	
FILO DISPENSA	
<i>FILO PULL OUT</i>	
ACCESSORI FIT/FILO	67
<i>ACCESSORIES FIT/FILO</i>	
NOMAD PORTAPOSATE	71
<i>NOMAD CUTLERY INSERTS</i>	
NOMAD DISPENSA	
<i>NOMAD PULL OUT</i>	
NOMAD ACCESSORI	73
<i>NOMAD ACCESSORIES</i>	
SISTEMA CASSETTO PORTAPOSATE	75
<i>DRAWER SYSTEM CUTLERY INSERTS</i>	
SISTEMA CASSETTO PORTAPIATTI	
<i>DRAWER SYSTEM DISH INSERTS</i>	
TECNOROCK PORTAPOSATE	
<i>TECNOROCK CUTLERY INSERTS</i>	
TECNOROCK DISPENSA	
<i>TECNOROCK PULL OUT</i>	
TECNOROCK ACCESSORI	77
<i>TECNOROCK ACCESSORIES</i>	
TAPPETINI	80
MAT	
TECHNICAL INFO	81





ESEMPIO CONFIGURAZIONE FIT PORTAPOSATE  
EXAMPLE OF FIT PORTAPOSATE CONFIGURATION

## X FIT

È l'innovativo sistema per la ripartizione di accessori interni che si adatta come un abito sartoriale all'interno dei cassetti di ogni cucina. Ricco e ricercato per design, con cura artigianale dei dettagli, **Fit** si contraddistingue per il suo slancio VERTICALE e per la sua eleganza che si adatta ad ogni situazione. Realizzato con materiali pregiati che comprendono speciali finiture antigraffio per un uso sempre sicuro e duraturo nel tempo. Le basi sono prodotte in MDF nero in pasta ed impiallacciate con essenze di legno nelle finiture Rovere Fiammato tinto Moka, Rovere tinto Nero e Noce Canaletto. Gli elementi divisori sono in legno massello nelle finiture Rovere Fiammato tinto Moka, Rovere tinto Nero e Noce Canaletto oppure in alluminio anodizzato Nero o verniciato Titanio. FIT è disponibile per cassetti con \*50 cm di profondità e \*45, \*60, \*75, \*90, \*105 e \*120 cm di larghezza.

*It is the innovative system for the distribution of internal accessories that fits like a sartorial dress inside the drawers of every kitchen. Rich and refined in design, with artisan attention to detail, FIT stands out for its VERTICAL momentum and for its elegance that adapts to every situation. Made with precious materials that include special anti-scratch finishes for a safe and long-lasting use. The bases are produced in black MDF paste and veneered with wood essences in the finishes Moka stained Flamed Oak, Black stained Oak and Canaletto Walnut. The dividing elements are in solid wood in the finishes Flamed Oak stained Moka, Oak stained Black and Canaletto Walnut or in black anodized aluminium or painted Titanium. FIT is available for drawers with \*50 cm depth and \*45, \*60, \*75, \*90, \*105 and \*120 cm width.*



ESEMPI CONFIGURAZIONE FIT PORTAPOSATE  
EXAMPLES OF FIT PORTAPOSATE CONFIGURATION



## X FIT - PORTAPOSATE

Fit Portaposate si divide in due tipologie:

- V1 - classica suddivisione degli spazi per la posateria e aree per gli accessori opzionali V1.
- V2 - contenimento più specifico per attrezzi da cucina e aree per gli accessori opzionali V1 e V2.

Entrambi possono essere arricchiti da elementi aggiuntivi opzionali per creare configurazioni ancora più complete ed accessoriate.

Accessori V1 con forma rettangolare:

- Portacoltelli, Portapellicole, Portacialde, Portaspezie, Set Pasta fresca.

Accessori V2 con forma quadrata:

- Portaspezie, Set Condimenti, Set Cocktail, Set Vino, Tagliere double-face.



*FIT CUTLERY HOLDER is divided into two types:*

- V1 - classic space division for cutlery and areas for optional accessories V1.
- V2 - more specific storage for kitchen utensils and areas for optional accessories V1 and V2.

Both can be enhanced with optional add-ons to create even more complete and accessorized configurations.

*V1 accessories with rectangular shape:*

- Knife Holder, Film Holder, Spice Holder, Fresh Pasta Set.

*Accessories V2 with square shape:*

- Spice rack, Seasoning set, Cocktail set, Wine set, Double-sided chopping board.



## X FIT - DISPENSA

Fit Dispensa è studiata e configurata in base a funzioni di contenimento specifiche, divise in 6 tipologie:

- V1 - fondo con guarnizioni antiscivolo (specifico per pentole);
- V2 - fondo con guarnizioni antiscivolo e divisori (specifico per pentole, scatolame, barattoli, piccoli contenitori);
- V3 - fondo con pilastri di contenimento regolabili (specifico per piatti);
- V4 - fondo con pilastri di contenimento regolabili e divisori (specifico per piatti, scatolame, barattoli, piccoli contenitori);
- V5 - fondo con divisori fissi (adatto per riporre scatolame, barattoli o generi alimentari confezionati);
- V6 - fondo con divisori e barattoli in vetro a tenuta ermetica.

Le dispense V1, V2, V3 e V4 possono essere arricchite da elementi opzionali.

Accessori dispensa: Portabottiglie, Box Accessori, Portabicchieri, Scolapiatti e Portapiatti.



*Fit Pull Out is designed and configured according to specific containment functions, divided into 6 types:*

- V1 - bottom with non-slip gaskets (suitable for pots and pans);
- V2 - bottom with non-slip gaskets and dividers (suitable for pots, boxes or jars);
- V3 - bottom with adjustable containment pillars (suitable for pots and pans);
- V4 - bottom with adjustable storage rails and dividers (suitable for pots, boxes or jars);
- V5 - bottom with fixed dividers (suitable for small boxes, jars or packaged food);
- V6 - bottom with dividers and accessory with 6 glass jars included.

The various pantries can be enriched with optional elements.

Pantry accessories: Bottle racks, Accessory Box, Cup holders, Drainers and Dishwasher and Dish racks.



ESEMPI CONFIGURAZIONE FIT DISPENSA  
EXAMPLES OF FIT DISPENSA CONFIGURATIONS



ESEMPIO CONFIGURAZIONE FILO PORTAPOSATE  
EXAMPLE OF FILO PORTAPOSATE CONFIGURATION

È l'innovativo sistema per la ripartizione di accessori interni che si adatta come un abito sartoriale all'interno dei cassetti di ogni cucina. Ricco e ricercato per design, con cura artigianale dei dettagli, FILO si contraddistingue per il suo slancio ORIZZONTALE e per la sua eleganza che si adatta ad ogni situazione. Realizzato con materiali pregiati che comprendono speciali finiture antigraffio per un uso sempre sicuro e duraturo nel tempo. Le basi sono prodotte in MDF nero in pasta ed impiallacciate con essenze di legno nelle finiture Rovere Fiammato tinto Moka, Rovere tinto Nero e Noce Canaletto. Gli elementi divisori sono in legno massello nelle finiture Rovere Fiammato tinto Moka, Rovere tinto Nero e Noce Canaletto oppure in alluminio anodizzato Nero o verniciato Titanio. FILO è disponibile per cassetti con \*50 cm di profondità e \*45,\*60,\*75,\*90,\*105 e \*120 cm di larghezza.

*It is the innovative system for the distribution of internal accessories that fits like a sartorial dress inside the drawers of every kitchen. Rich and refined in design, with hand-crafted attention to detail, FILO stands out for its HORIZONTAL momentum and for its elegance that adapts to any situation. Made with precious materials that include special anti-scratch finishes for a safe and long-lasting use.*

*The bases are produced in black MDF paste and veneered with wood essences in the finishes Moka stained Flamed Oak, Black stained Oak and Canaletto Walnut.*

*The dividing elements are in solid wood in the finishes Flamed Oak stained Moka, Oak stained Black and Canaletto Walnut or in black anodized aluminium or painted Titanium. FILO is available for drawers with \*50 cm depth and \*45, \*60, \*75, \*90, \*105 and \*120 cm width.*



ESEMPIO CONFIGURAZIONE FILO DISPENSA  
EXAMPLE OF FILO DISPENSA CONFIGURATION

## X FILO - PORTAPOSATE

Filo Portaposate si divide in due tipologie:

- V1 - classica suddivisione degli spazi per la posateria e aree per gli accessori opzionali V1.
- V2 - contenimento più specifico per attrezzi da cucina e aree per gli accessori opzionali V1 e V2.

Entrambi possono essere arricchiti da elementi aggiuntivi opzionali per creare configurazioni ancora più complete ed accessoriate.

Accessori V1 con forma rettangolare:

- Portacoltelli, Portapellicole, Portacialde, Portaspezie, Set Pasta fresca.

Accessori V2 con forma quadrata:

- Portaspezie, Set Condimenti, Set Cocktail, Set Vino, Tagliere double-face

*Filo Cutlery Holders is divided into two types:*

- V1 - classic space division for cutlery and areas for optional accessories V1.
- V2 - more specific storage for kitchen tools and areas for optional accessories V1 and V2.

*Both can be enhanced with optional add-ons to create even more complete and accessorized configurations.*

*V1 accessories with rectangular shape:*

- Knife Holder, Film Holder, Spice Holder, Fresh Pasta Set.

*Accessories V2 with square shape:*

- Spice rack, Seasoning set, Cocktail set, Wine set, Double-sided chopping board.



## X FILO - DISPENSA

Filo Dispensa è studiata e configurata in base a funzioni di contenimento specifiche, divise in 6 tipologie:

- V1 - fondo con guarnizioni antiscivolo (specifico per pentole);
- V2 - fondo con guarnizioni antiscivolo e divisori (specifico per pentole, scatolame, barattoli, piccoli contenitori);
- V3 - fondo con pilastri di contenimento regolabili (specifico per piatti);
- V4 - fondo con pilastri di contenimento regolabili e divisori (specifico per piatti, scatolame, barattoli, piccoli contenitori);
- V5 - fondo con divisori fissi (adatto per riporre scatolame, barattoli o generi alimentari confezionati);
- V6 - fondo con divisori e barattoli in vetro a tenuta ermetica.

Le dispense V1, V2, V3 e V4 possono essere arricchite da elementi opzionali.

Accessori dispensa: Portabottiglie, Box Accessori, Portabicchieri, Scolapiatti e Portapiatti.

*Filo Pull Out is designed and configured on the basis of specific containment functions, divided into 6 typologies:*

- V1 - bottom with non-slip gaskets (specific for pots and pans);
- V2 - bottom with non-slip gaskets and dividers (specific for pots, cans, jars, small containers);
- V3 - bottom with adjustable containment pillars (specific for pots and pans);
- V4 - bottom with adjustable containment pillars and dividers (specific for pots, cans, jars, small containers);
- V5 - bottom with fixed dividers (suitable for storing cans, jars or packaged foodstuffs);
- V6 - bottom with airtight glass dividers and jars.

*The V1, V2, V3 and V4 pantries can be enriched with optional elements.*

*Pantry accessories: Bottle racks, Accessory Box, Glass racks, Dishwasher and dish rack.*



ESEMPI CONFIGURAZIONE FILO PORTAPOSATE E FILO DISPENSA  
EXAMPLES OF FILO PORTAPOSATE AND FILO DISPENSA CONFIGURATIONS



ESEMPI CONFIGURAZIONE FILO DISPENSA  
 EXAMPLES OF FILO DISPENSA CONFIGURATIONS



ESEMPI CONFIGURAZIONE FILO PORTAPOSATE E FILO DISPENSA  
 EXAMPLES OF FILO PORTAPOSATE AND FILO DISPENSA CONFIGURATIONS

- DIVISORIO "T" - componente per dividere il vano accessori in ulteriori 3 scomparti;
- PORTACOLTELLI - elegante e funzionale dove riporre i coltelli in modo stabile e sicuro;
- PORTAPELLICOLE - pratico elegante e funzionale doppio dispenser, anima porta tubo per facilitare la rotazione, i coperchi sono dotati di zigrinatura e guarnizioni per ammortizzarne la chiusura.
- PORTACIALDE - dispenser dove riporre fino a 30 cialde o capsule del caffè;
- PORTASPEZIE UNIVERSALE - accessorio dove riporre differenti tipi di barattoli di spezie, sali o alimenti di piccole dimensioni;
- PORTASPEZIE V1V - accessorio con barattoli in vetro dove riporre spezie, sali o alimenti di piccole dimensioni;
- PORTASPEZIE V1N - accessorio con barattoli in vetro e tappo di chiusura a vite dove riporre spezie, sali o alimenti di piccole dimensioni;
- SET PASTA FRESCA - set dedicato alla preparazione di impasti, comprende un innovativo mattarello ed una rotella taglia pasta.

- *DIVISORY "T" - component to divide the accessories compartment into 3 additional compartments;*
- *KNIVES HOLDER - elegant and functional where to store knives in a stable and safe way;*
- *FILM HOLDER - practical elegant and functional double dispenser, tube holder core to facilitate rotation, the lids are equipped with knurling and seals to cushion the closure.*
- *POD HOLDER - dispenser where to store up to 30 coffee pods or capsules;*
- *SPICE CONTAINER - accessory where to store different types of jars of spices, salts or small food;*
- *SPICE CONTAINER V1V - accessory with glass jars where to store spices, salts or small food;*
- *SPICE CONTAINER V1N - accessory with glass jars and screw cap where to store spices, salts or small food;*
- *FRESH PASTA SET - set dedicated to the preparation of dough, includes an innovative rolling pin and a pasta cutter.*



DIVISORIO "T"  
DIVISORY "T"



PORTACOLTELLI  
KNIVES HOLDER



PORTAPELLICOLE  
FILM HOLDER



PORTACIALDE  
POD HOLDER



SET PASTA FRESCA  
FRESH PASTA SET



PORTASPEZIE UNIVERSALE  
SPICE CONTAINER



PORTASPEZIE V1N  
SPICE CONTAINER V1N



PORTASPEZIE V1V  
SPICE CONTAINER V1V

- PORTASPEZIE V2V - accessorio con barattoli in vetro dove riporre spezie, sali o alimenti di piccole dimensioni;
- PORTASPEZIE V2N - accessorio con barattoli in vetro e tappo di chiusura a vite dove riporre spezie, sali o alimenti di piccole dimensioni;
- SET CONDIMENTI - accessorio completo di 4 minimacina per spezie o sali e 2 innovative oliere da 250 ml in acciaio inox.
- SET COCKTAIL - accessorio elegante e pratico completo di strumenti per la preparazione di cocktails ( Shaker, Jegger, Pinza ghiaccio e pestello);
- SET VINO - elegante set dedicato agli amanti del vino (cavatappi professionale Roero, tappo champagne, salva goccia, versatore vino in acciaio inox, preserva vino con due tappi in silicone);
- \*TAGLIERE DOUBLE FACE - comodo, pratico e funzionale tagliere in legno massello con finitura ad olio per uso alimentare.

\*NON ADATTO AL LAVAGGIO IN LAVASTOVIGLIE.

- *SPICES CONTAINER V2V - accessory with glass jars where to store spices, salts or small food;*
- *SPICES CONTAINER V2N - accessory with glass jars and screw cap where to store spices, salts or small food;*
- *CONDIMENTS SET - accessory complete with 4 small spices or salts and 2 innovative 50 ml stainless steel oil jars.*
- *COCKTAIL SET - elegant and practical accessory complete with tools for the preparation of cocktails (Shaker, Jigger, ice pliers and pestle);*
- *WINE SET - elegant set dedicated to wine lovers (Roero professional corkscrew, champagne cork, drop saver, stainless steel wine pourer, wine preserver with two silicone stoppers);*
- *\*DOUBLE FACE CHIPPER - comfortable, practical and functional solid wood chopping board with oil finish for food use.*

\*NOT SUITABLE FOR WASHING IN THE DISHWASHER



PORTASPEZIE V2V  
SPICE CONTAINER V2V



PORTASPEZIE V2N  
SPICE CONTAINER V2N



SET CONDIMENTI  
CONDIMENTS SET



SET COCKTAIL  
COCKTAIL SET



SET VINO  
WINE SET



TAGLIERE DOUBLE FACE  
DOUBLE FACE CHIPPER



TAGLIERE DOUBLE FACE  
DOUBLE FACE CHIPPER

**X** FIT/FILO  
ACCESSORI DISPENSA

Eleganti, pratici e funzionali box multiuso in acciaio verniciato e legno, da riporre all'interno delle dispense V1 e V2.

Sono suddivisi in 5 tipologie:

- PORTABOTTIGLIE - vassoio con divisorio per riporre fino ad 8 bottiglie;
- BOX ACCESSORI - vassoio dove poter alloggiare bottiglie e vani per posate o altri accessori;
- PORTABICCHIERI - vassoio con divisori per riporre fino ad 8 bicchieri;
- SCOLAPIATTI - vassoio scolapiatti dove riporre ordinatamente fino a 11 pezzi.
- PORTAPIATTI - vassoio dove riporre ordinatamente fino a 11 piatti.

*Elegant, practical and functional multipurpose box in painted steel and wood, to be stored inside the V1 and V2 pantries.*

*They are divided into 5 types:*

- *BOTTLE HOLDER - tray with divider for storing up to 8 bottles;*
- *BOX ACCESSORIES - tray where bottles and compartments for cutlery or other accessories can be stored;*
- *GLASS HOLDER - tray with dividers for storing up to 8 glasses;*
- *RACKS - tray where to store up to 11 pieces neatly.*
- *DISH HOLDER - tray to store up to 11 plates in an orderly manner.*



PORTABOTTIGLIE  
BOTTLE HOLDER



BOX ACCESSORI  
BOX ACCESSORIES



PORTABICCHIERI  
GLASS HOLDER



PORTAPIATTI  
DISH HOLDER



SCOLAPIATTI  
DISH HOLDER

**X** FIT/FILO PORTAPOSATE  
COMPENSATORE DI PROFONDITÀ

Il compensatore viene utilizzato all'interno dei cassetti con profondità 60 cm. Può essere abbinato al fondo Portaposate. Il compensatore è disponibile per cassetti da \*45, \*60, \*75, \*90, \*105 e \*120 cm. di larghezza.

*The compensator is used inside the 60cm deep drawers. It can be combined with the cutlery holder base. The compensator is available for drawers of \*45, \*60, \*75, \*90, \*105 and \*120 cm. width.*



**X** FIT/FILO DISPENSA  
COMPENSATORE DI PROFONDITÀ

Il compensatore viene utilizzato all'interno dei cassetti con profondità 60 cm. Può essere abbinato al fondo Dispensa. Il compensatore è disponibile per cassetti da \*45, \*60, \*75, \*90, \*105 e \*120 cm. di larghezza.

*The compensator is used inside the 60cm deep drawers. It can be combined with the Pull Out base. The compensator is available for drawers of \*45, \*60, \*75, \*90, \*105 and \*120 cm. width.*



**X** NOMAD  
PORTAPOSATE

Nomad è sinonimo di totale libertà e fantasia per l'organizzazione interna dei cassetti. Grazie ai diversi singoli elementi e accessori del programma è possibile creare infinite combinazioni a seconda del gusto e delle esigenze dell'utente finale. Nomad può essere installato su ogni sistema di cassetti con profondità interna di 472 mm, mentre non ci sono limiti nella dimensione della larghezza. Nomad è realizzato in Frassino massello verniciato Nero Opaco.

*Nomad is synonymous of total freedom and fantasy for the inner drawers organization. Thanks to the several single elements and accessories of the program, it is possible to create unlimited combination according to the taste and needs of the end user. Nomad can be installed on every drawer system with inner depth 472 mm, while there are no limits in the width dimension. Nomad is made of solid Ash painted Black Matt.*



**X** NOMAD  
DISPENSA

Nomad è sinonimo di totale libertà e fantasia per l'organizzazione interna dei cassettoni. Grazie ai diversi singoli elementi e accessori del programma è possibile creare infinite combinazioni a seconda del gusto e delle esigenze dell'utente finale. Nomad può essere installato su ogni sistema di cassettoni con profondità interna di 472 mm. Le basi forate possono essere orientate, tagliando i fianchi, per adattarsi perfettamente ad ogni cassettoni. Nomad è realizzato in Frassino massello verniciato Nero Opaco.

*Nomad is synonymous of total freedom and fantasy for the inner drawers organization. Thanks to the several single elements and accessories of the program, it is possible to create unlimited combination according to the taste and needs of the end user. Nomad can be installed on every drawer system with inner depth 472 mm. The drilled bases can be adjusted, cutting the sides, to sharply fit every drawer. Nomad is made of solid Ash painted Black Matt.*

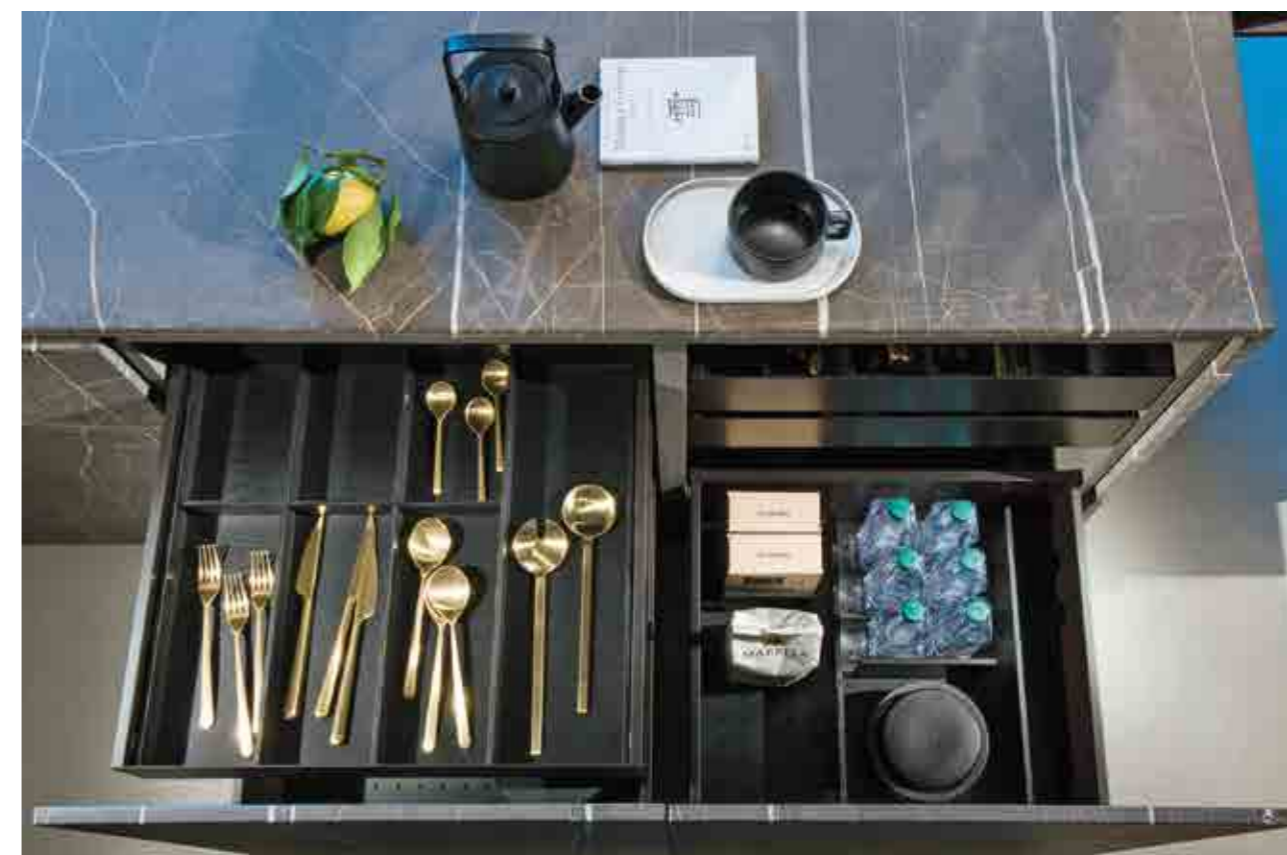

ESEMPI CONFIGURAZIONE NOMAD PORTAPOSATE  
EXAMPLES OF NOMAD PORTAPOSATE CONFIGURATIONS



Accessori portaposate:

- PORTAPELLICOLE - pratico, funzionale ed elegante doppio dispenser completamente realizzati in acciaio inox AISI 304/ Frassino massello tinto Nero Opaco;
- PORTACOLTELLI - elegante e pratico realizzato Frassino massello tinto Nero Opaco dove riporre i coltelli in modo stabile e sicuro;
- PORTASPEZIE - accessorio con barattoli in vetro e tappo di chiusura a vite dove riporre spezie, sali o alimenti di piccole dimensioni;
- TAGLIERE - comodo, pratico e funzionale tagliere in polietilene Bianco per uso alimentare.

Cutlery holder accessories:

- FILM HOLDERS - practical, functional and elegant double dispenser completely made of AISI 304/Frassino solid stainless steel stained Matt Black;
- KNIVES HOLDER - elegant and practical made of solid Ash stained Matt Black where to store the knives in a stable and safe way;
- SPICES HOLDER - accessory with glass jars and screw cap where to store spices, salts or small food;
- CHOPPING BOARD - comfortable, practical and functional chopping board in White polyethylene for food use.

Accessori dispensa:

- SET BARATTOLI PORTA PASTA - Pratico ed elegante set di barattoli in Vetro Borosilicato con tappi a chiusura ermetica dove poter riporre Pasta, Riso o altri alimenti;
- SET PILASTRINI - pilastri di contenimento regolabili in Frassino massello verniciato Nero Opaco dove riporre in maniera ordinata e stabile qualsiasi dimensione dei piatti;
- SET PORTABOTTIGLIE - per gli amanti del vino, pratico e stabile accessorio in Frassino massello verniciato Nero Opaco dove adagiare ordinatamente le bottiglie di vino;
- SET DIVISORI - pratici e stabili divisori in Frassino massello verniciato Nero Opaco liberamente posizionabili sul fondo dispensa dove poter riporre scatole, barattoli o qualsiasi alimento confezionato;
- SET GRIP - accessorio in materiale silicico antiscivolo posizionabile nei fori del fondo dispensa;
- SET PORTAPIATTI - comodo e stabile divisorio in Frassino massello verniciato Nero Opaco dove riporre fino a 12 piatti;
- SET PORTACOPERCHI - pratico accessorio in Frassino massello verniciato Nero Opaco per posare i coperchi in modo stabile e ordinato;
- SET PORTAOGGETTI - elegante e funzionale accessorio in Frassino massello verniciato Nero Opaco e funzionale dove riporre oggetti come portaspezie, sali, alimenti confezionati di piccole dimensioni, ecc.

PULL OUT accessories:

- PASTA COOKER SET - practical and elegant set of Borosilicate Glass jars with hermetically sealed caps where you can store Pasta, Rice or other food;
- PINS SET - adjustable storage pilasters in solid Ash painted Matt Black where you can store in an orderly and stable way any size of dishes;
- BOTTLE HOLDER SET - for wine lovers, practical and stable accessory in solid Ash painted Matt Black where you can place wine bottles in an orderly and stable way;
- DIVIDERS SET - practical and stable solid Ashwood dividers painted Matt Black, which can be freely positioned on the bottom pantry where you can store cans, jars or any packaged food;
- GRIP SET - accessory in non-slip silicone material that can be positioned in the holes of the pantry bottom;
- PLATES HOLDER SET - comfortable and stable solid Ashwood partition painted Matt Black where you can store up to 12 plates;
- LIDS HOLDER SET - practical accessory in solid Ash painted Matt Black to place the lids in a stable and tidy way;
- OBJECTS HOLDER SET - elegant and functional accessory in solid Ash painted Matt Black where to store objects such as spice holders, salts, small packaged food, etc..



ACCESSORIO PORTAPELLICOLA  
FILM DISPENSER



ACCESSORIO PORTACOLTELLI  
KNIFE HOLDER



ACCESSORIO PORTASPEZIE  
SPICE CONTAINERS SET



TAGLIERE  
BIG CONTAINERS SET



SET BARATTOLI PORTAPASTA  
BIG CONTAINERS SET



SET PILASTRINI  
PINS SET



ESEMPIO CONFIGURAZIONE NOMAD DISPENSA  
EXAMPLE OF NOMAD DISPENSA CONFIGURATION



SET PORTABOTTIGLIE  
BOTTLE HOLDERS SET



SET PORTAPIATTI  
PLATES HOLDER SET



SET DIVISORI  
DIVIDERS SET



SET PORTACOPERCHI  
LID HOLDER SET



SET GRIP  
GRIP SET



SET PORTAOGGETTI  
OBJECTS HOLDER SET

## SISTEMA CASSETTO PORTAPOSATE

Con **Sistema Cassetto** nasce il modo più brillante e rivoluzionario di organizzare lo spazio di piatti, posate e coltelli nei cassettoni di ogni cucina. Sistema Cassetto è innovativo perchè è un monoblocco immediatamente pronto per l'uso. Disponibile per cassettoni con \*50 cm di profondità e per \*45, \*60, \*90 e \*120 cm di larghezza. Il prodotto è realizzato in acciaio inox AISI 304 e Faggio Naturale evaporato.

*The Drawer System represents a revolutionary and brilliant way of reorganising space for cutlery and crockery in every kitchen drawer. Its innovation is that it is a single piece, ready to use so does not require fitting. Available for drawers with \*50 cm depth and for \*45, \*60, \*90 and \*120 cm width. The product is made of AISI 304 stainless steel and evaporated Natural Beech.*



## SISTEMA CASSETTO PORTAPIATTI

Con **Sistema Cassetto** nasce il modo più brillante e rivoluzionario di organizzare lo spazio di piatti, posate e coltelli nei cassettoni di ogni cucina. Sistema Cassetto è innovativo perchè è un monoblocco immediatamente pronto per l'uso e non necessita di montaggio. Disponibile per cassettoni con \*50 cm di profondità e per \*45, \*60, \*90 e \*120 cm di larghezza. Il prodotto è realizzato in acciaio inox AISI 304 e Faggio Naturale evaporato.

*The Drawer System represents a revolutionary and brilliant way of reorganising space for cutlery and crockery in every kitchen drawer. Its innovation is that it is a single piece, ready to use so does not require fitting. Available for drawers with \*50 cm depth and for \*45, \*60, \*90 and \*120 cm width. The product is made of AISI 304 stainless steel and evaporated Natural Beech.*



## TECNOROCK PORTAPOSATE

**Tecnorock**, sistema di attrezzature interne per cassettoni, nasce come mix tra la tecnica e la pulizia dell'acciaio inox ed il calore e l'eleganza del legno. Unici e caratteristici, i divisori dalle forme sottili, in legno massello di Noce o in Rovere scuro, conferiscono al prodotto un aspetto di leggerezza e di eleganza. La suddivisione verticale degli spazi permette di organizzare ordinatamente sia la posateria che gli accessori opzionali come Portafilmi, Portacoltelli e Portaspezie. Disponibile per cassettoni con \*50 cm di profondità e per \*45, \*60, \*75, \*90, \*105 e \*120 cm di larghezza. Tecnorock viene prodotto in due finiture, acciaio inox AISI 304/Noce e acciaio inox AISI 304/Rovere scuro.

*Tecnorock was conceived as a mix of materials, blending the technical look and cleanliness of stainless steel with the warmth and elegance of wood. With a unique and characteristic look, the thinly-shaped dividers in solid walnut or smoked oak wood, confer lightness and elegance to the whole kit. The vertical division of spaces allows you to organize neatly both the cutlery and optional accessories such as film holders, knife holders and spice holders. Available for drawers with \*50 cm depth and for \*45, \*60, \*75, \*90, \*105 and \*120 cm width. Tecnorock is produced in two finishes, stainless steel AISI 304/Walnut and stainless steel AISI 304/Smoked Oak.*



## TECNOROCK DISPENSA

**Tecnorock**, sistema di attrezzature interne per cassettoni, nasce come mix tra la tecnica e la pulizia dell'acciaio inox e il calore e l'eleganza del legno. Unici e caratteristici, i divisori dalle forme sottili, in legno massello di Noce o in Rovere Scuro, conferiscono al prodotto un aspetto di leggerezza e di eleganza. La suddivisione degli spazi permette di organizzare ordinatamente sia scatolame, barattoli e generi alimentari confezionati, che gli accessori opzionali come Set Barattoli Portapasta, Set Contenitori Inox e Accessorio Portapiatti. Disponibile per cassettoni con \*50 cm di profondità e per \*60, \*75, \*90, \*105 e \*120 cm di larghezza. Tecnorock viene prodotto in due finiture, acciaio inox AISI 304/Noce e acciaio inox AISI 304/Rovere scuro.

*Tecnorock was conceived as a mix of materials, blending the technical look and cleanliness of stainless steel with the warmth and elegance of wood. With a unique and characteristic look, the thinly-shaped dividers in solid Walnut or Smoked Oak wood, confer lightness and elegance to the whole kit. The division of spaces allows you to organize neatly both cans, jars and packaged groceries, as well as optional accessories such as Big Containers Set, Stainless Steel Containers Set and Plates Holder. Available for drawers with \*50 cm depth and for \*60, \*75, \*90, \*105 and \*120 cm width. Tecnorock is produced in two finishes, stainless steel AISI 304/Walnut and stainless steel AISI 304/Smoked Oak.*



ESEMPIO  
CONFIGURAZIONE  
TECNOROCK  
PORTAPOSATE  
EXAMPLE OF TECNOROCK  
PORTAPOSATE CONFIGU-  
RATION



Accessori portaposate:

- PORTAPELLICOLA - pratico, funzionale ed elegante dispenser singolo completamente realizzato in acciaio inox AISI 304;
- PORTACOLTELLI - elegante nel mix Acciaio inox AISI 304/Noce e funzionale dove riporre i coltelli in modo stabile e sicuro;
- PORTASPEZIE - accessorio con barattoli in vetro e tappo di chiusura a vite dove riporre spezie, sali o alimenti di piccole dimensioni;

Accessori dispensa:

- SET BARATTOLI PORTAPASTA - Pratico ed elegante set di barattoli in Vetro Borosilicato con tappi a chiusura ermetica dove poter riporre Pasta, Riso o altri alimenti;
- SET CONTENITORI - elegante nel mix Acciaio inox AISI 304/Noce e funzionale dove riporre oggetti di piccole dimensioni come portaspesie, sali ecc.
- SET PORTAPIATTI REGOLABILE - elegante nel mix Acciaio inox AISI 304/Noce, funzionale dove riporre i piatti di diversi diametri e pratico da posizionare all'interno del cassetto o sul piano cucina.

Cutlery holder accessories:

- FILM DISPENSER - practical, functional and elegant single dispenser completely made of AISI 304 stainless steel;
- KNIFE HOLDER - elegant in the mix stainless steel AISI 304/Walnut and functional where to store the knives in a stable and safe way;
- SPICES HOLDER - accessory with glass jars and screw cap where to store spices, salts or small food;

PULL OUT accessories:

- PASTA COOKERS SET - Practical and elegant set of Borosilicate Glass jars with hermetically sealed caps where you can store Pasta, Rice or other food;
- CONTAINERS SET - elegant in the mix stainless steel AISI 304/Walnut and functional where to store small objects such as spices, salt, etc..
- ADJUSTABLE PLATE HOLDERS SET - elegant in the mix stainless steel AISI 304/Walnut, functional where to store plates of different diameters and practical to place inside the drawer or on the kitchen top.



ACCESSORIO PORTAPELLICOLA  
FILM DISPENSER



SET BARATTOLI PORTAPASTA  
BIG CONTAINERS SET

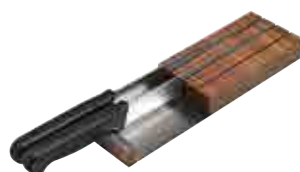

ACCESSORIO PORTACOLTELLI  
KNIFE HOLDER



SET CONTENITORI INOX  
INOX CONTAINERS SET



ACCESSORIO PORTASPEZIE  
SPICE CONTAINERS SET



ACCESSORIO PORTAPIATTI  
PLATE HOLDER



ESEMPIO CONFIGURAZIONE TECNOROCK ACCESSORI  
EXAMPLE OF TECNOROCK ACCESSORIES CONFIGURATION



## X RIVESTIMENTO PER CASSETTI TEX-MAT

Tecnoinox incrementa la gamma accessori per cassetti con la nuova linea **Tex-Mat**. Elegante e pratico tappetino che protegge ed impreziosisce l' interno cassetto. Il rivestimento è realizzato in tessuto tecnico lavabile e grazie al suo mix di fibre poliestere completamente prive di ftalati, ha tra le sue migliori caratteristiche la morbidezza al tatto, la resistenza alle abrasioni, la facilità di pulizia e di lavaggio, l' asciugatura rapida ed una bassa porosità che migliora la resistenza alle macchie. Disponibile nelle misure 45, 60, 75, 90, 105 e 120 cm di larghezza e nelle 2 finiture Grigio Chiaro e Grigio Acciaio.

*Tecnoinox increases the range of accessories for drawers with the new Tex-Mat line. Elegant and practical mat that protects and enhances the inside of the drawer. The cover is made of washable technical fabric and, thanks to its mix of polyester fibres completely free of phthalates, has among its best features softness to the touch, resistance to abrasions, ease of cleaning and washing, quick drying and a low porosity that improves stain resistance. Available in sizes 45, 60, 75, 90, 105 and 120 cm width and in 2 finishes Light Grey and Steel Grey.*

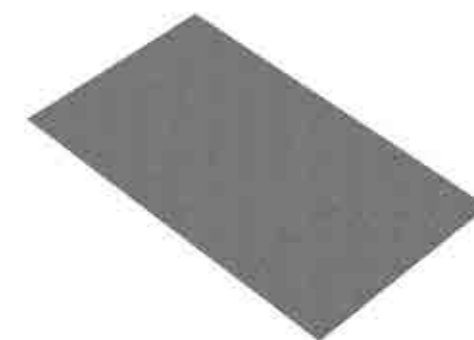

FIT POSATE 45

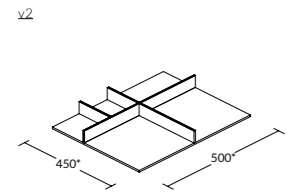
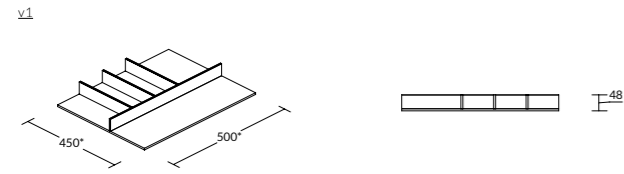

FIT POSATE 90

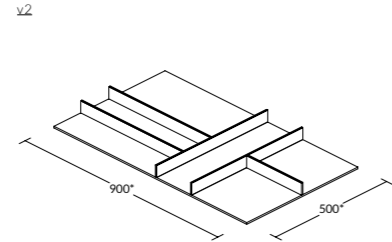
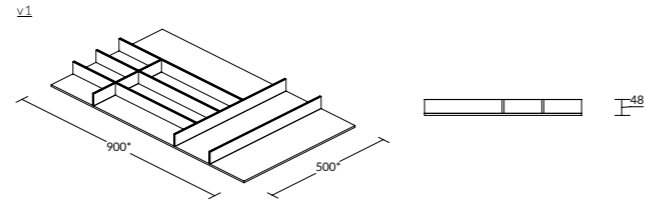

FIT POSATE 60

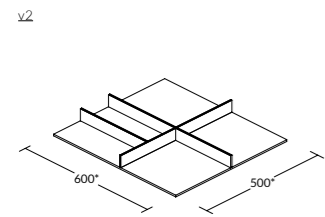
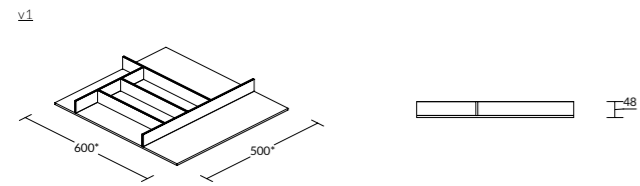

FIT POSATE 105

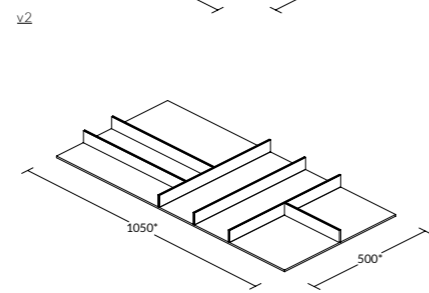
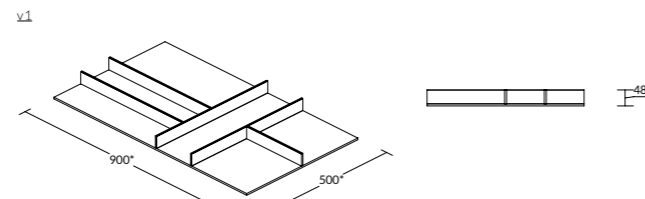

FIT POSATE 75

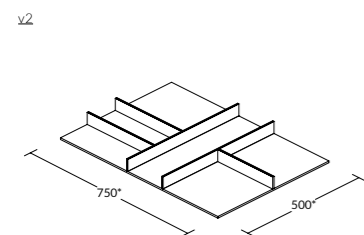
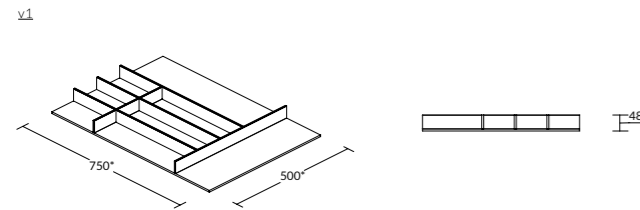

FIT POSATE 120

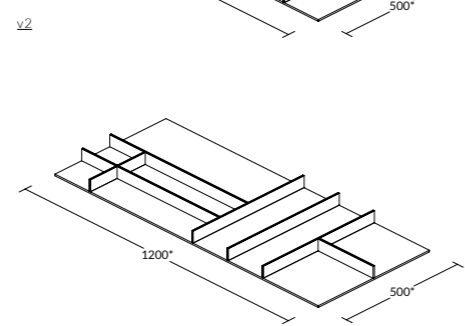
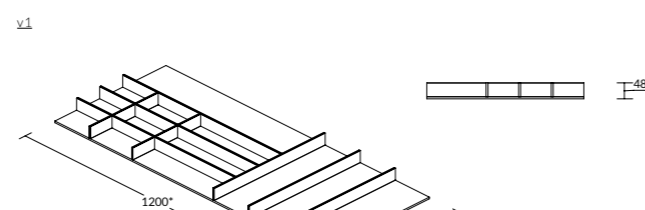

FIT DISPENSA 60

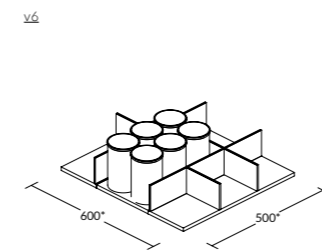
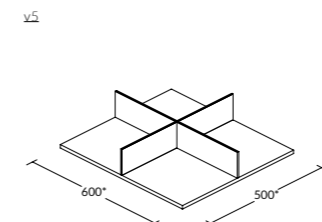
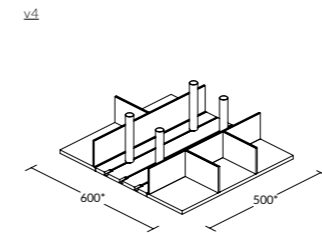
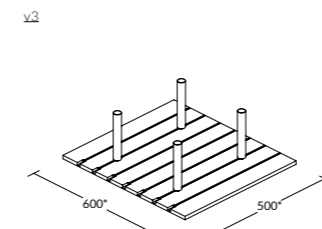
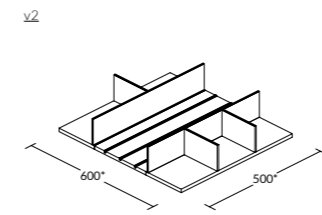
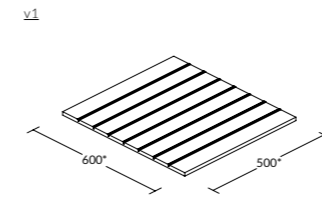

FIT DISPENSA 75

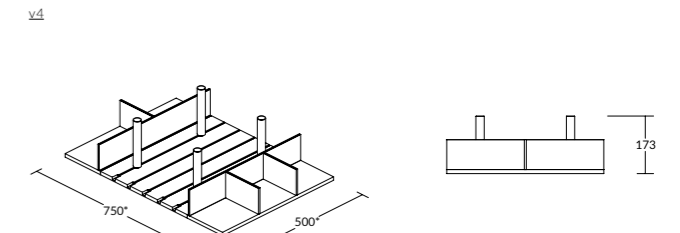
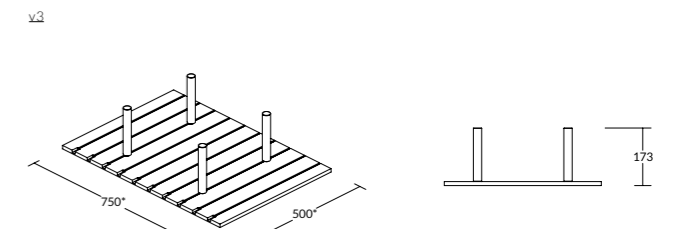
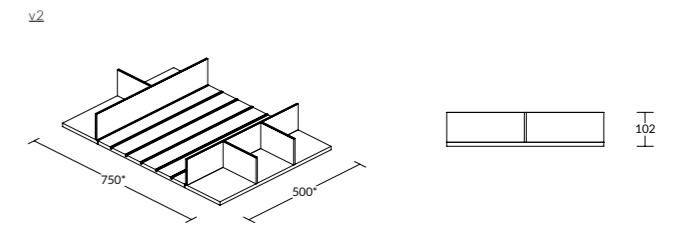
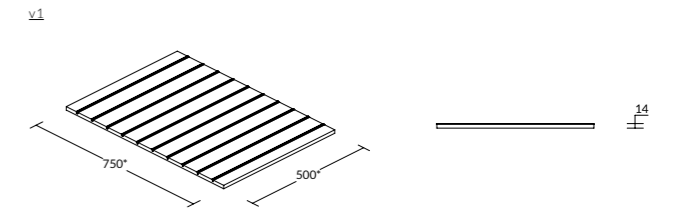

FIT DISPENSA 90

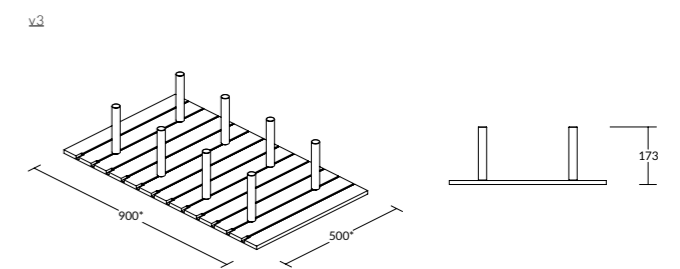
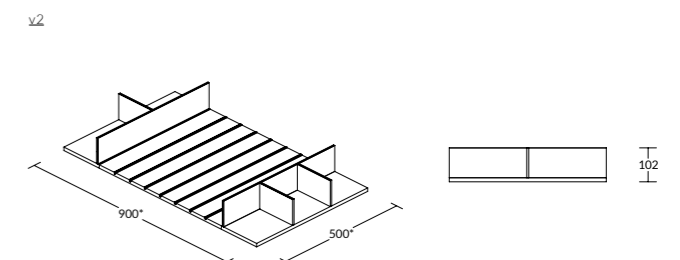
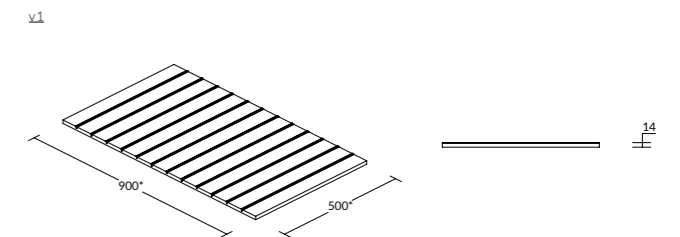

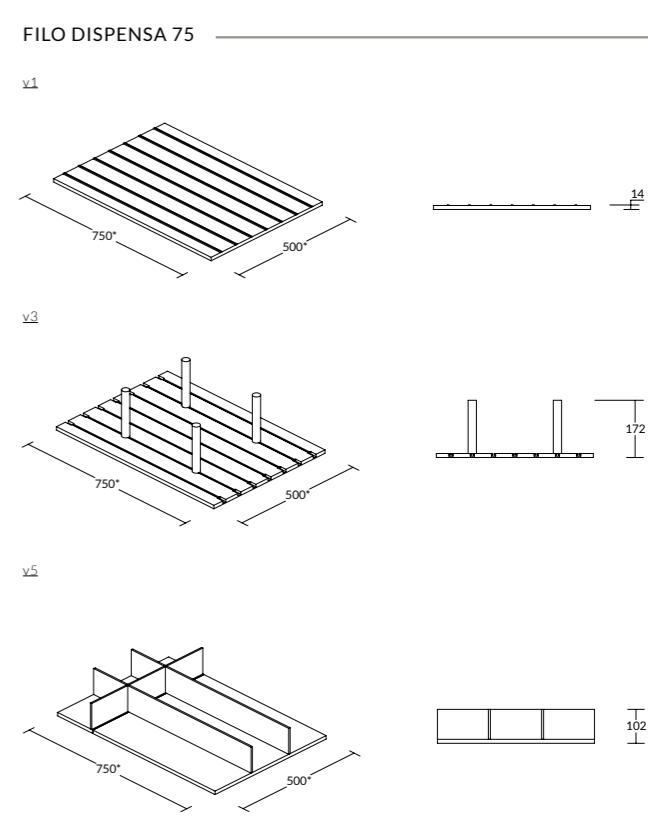
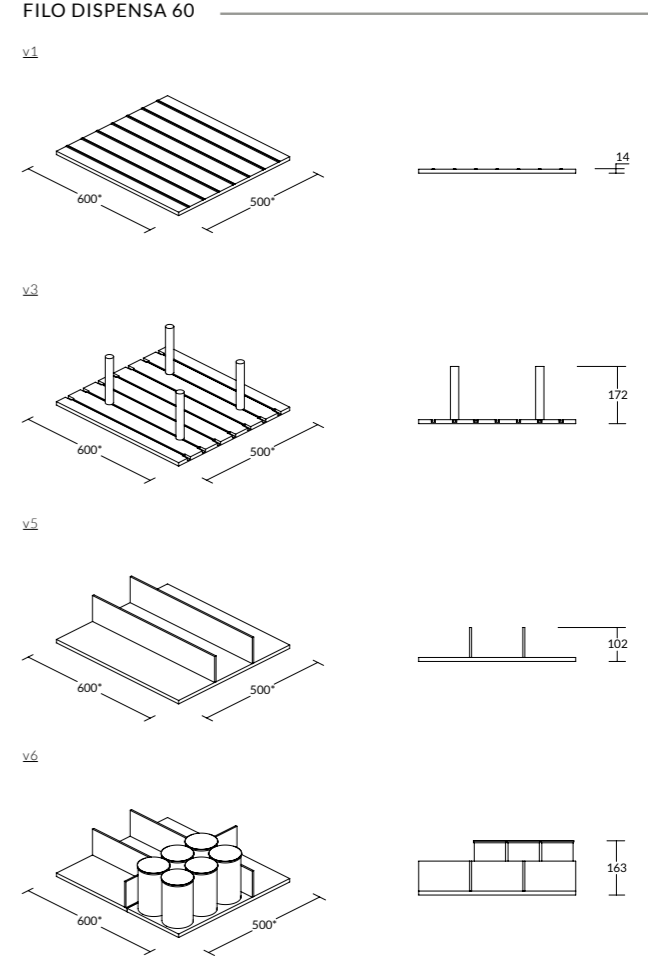
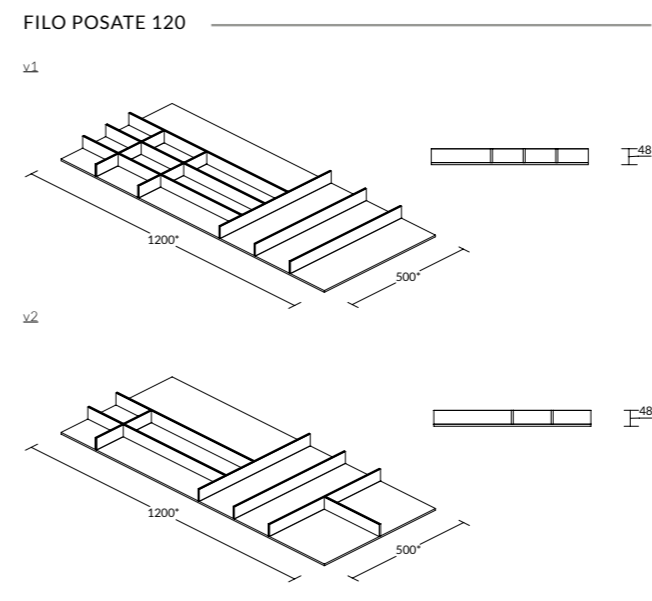
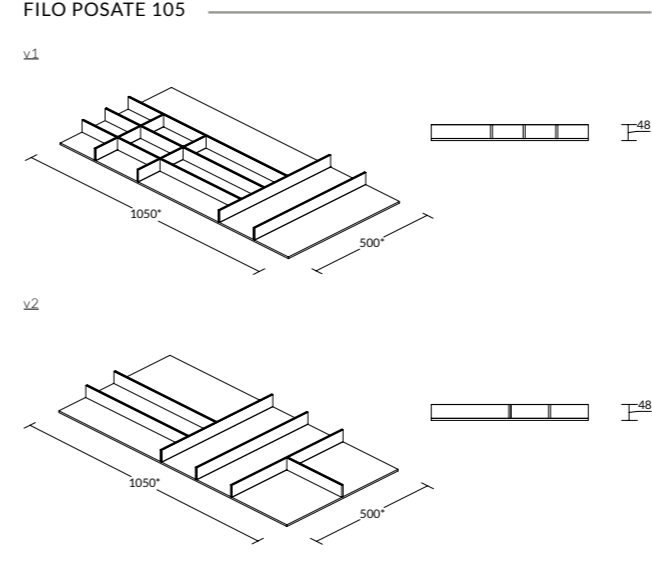
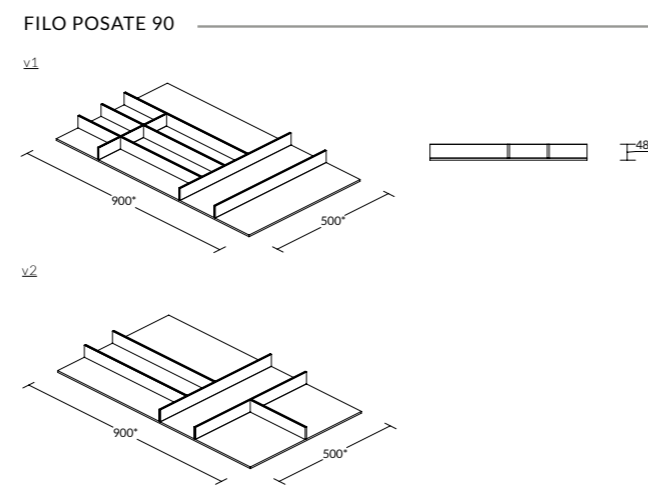
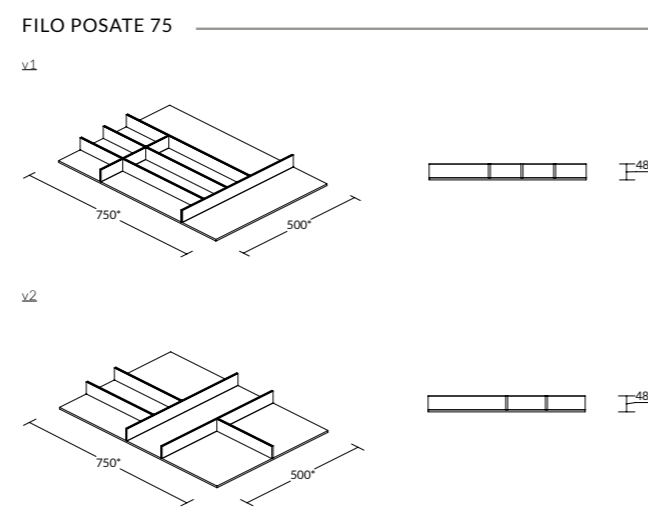
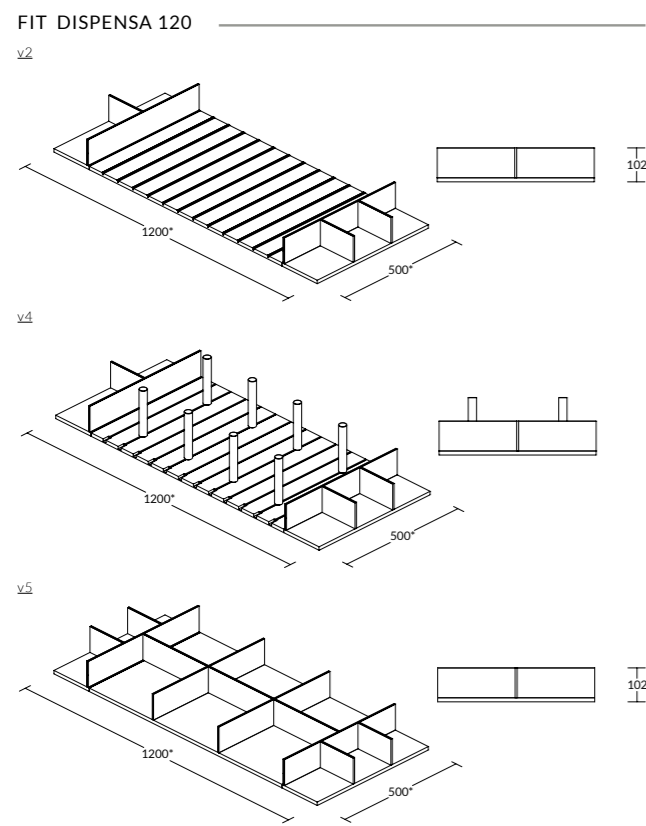
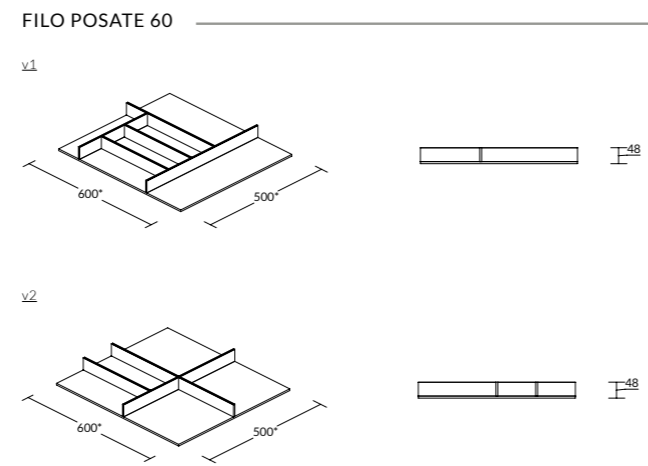
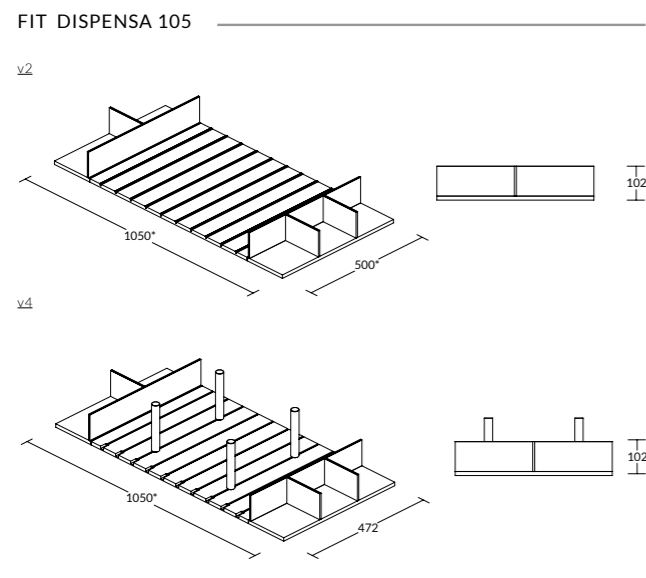
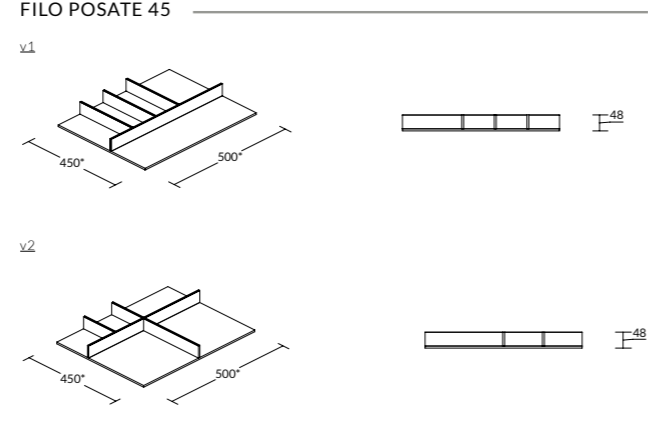
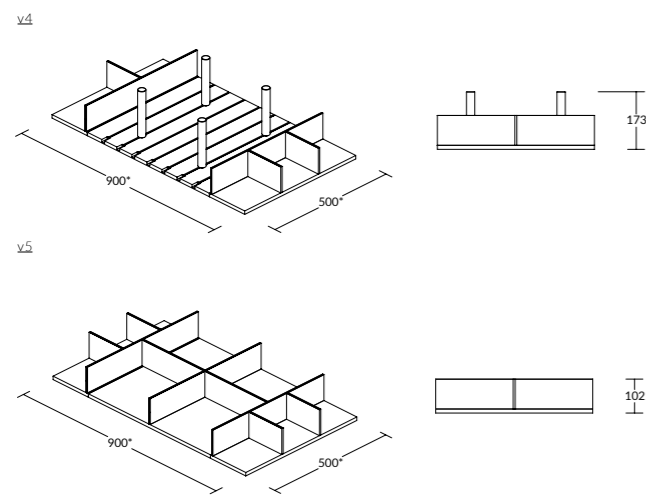

FILO DISPENSA 90

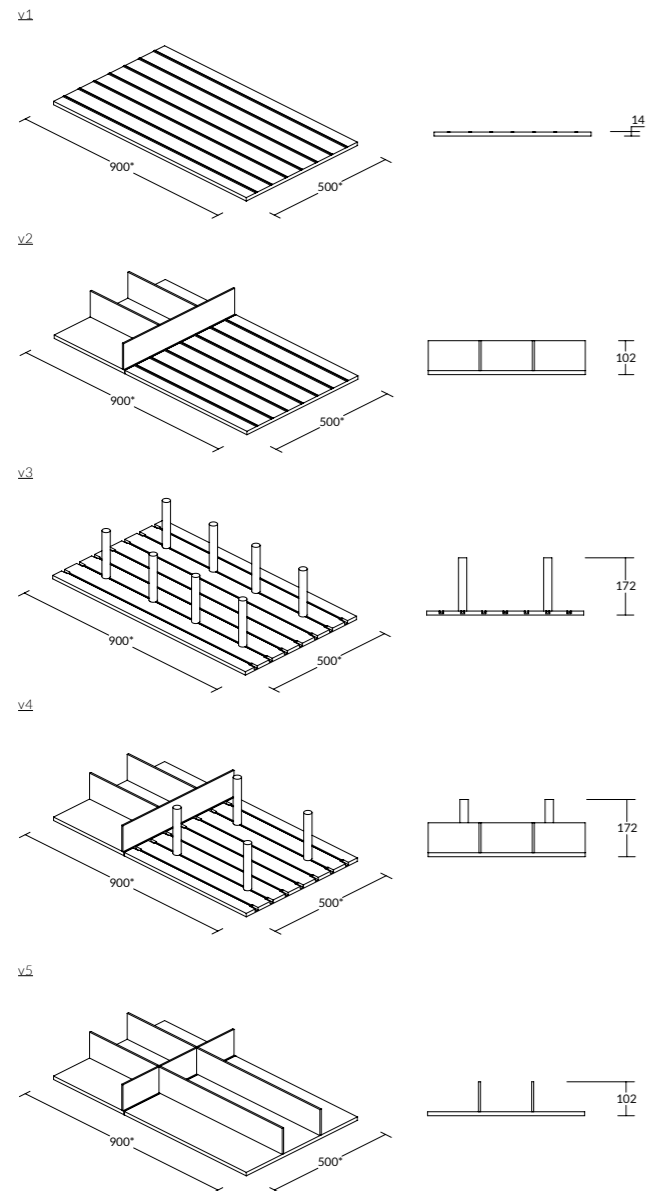

FILO DISPENSA 105

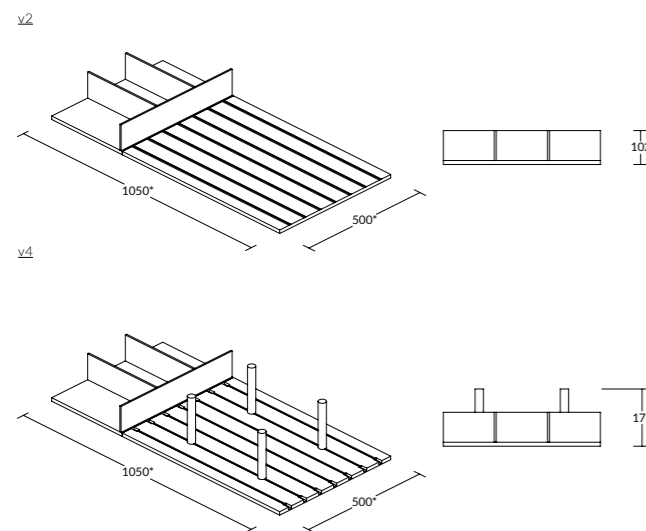

FILO DISPENSA 120

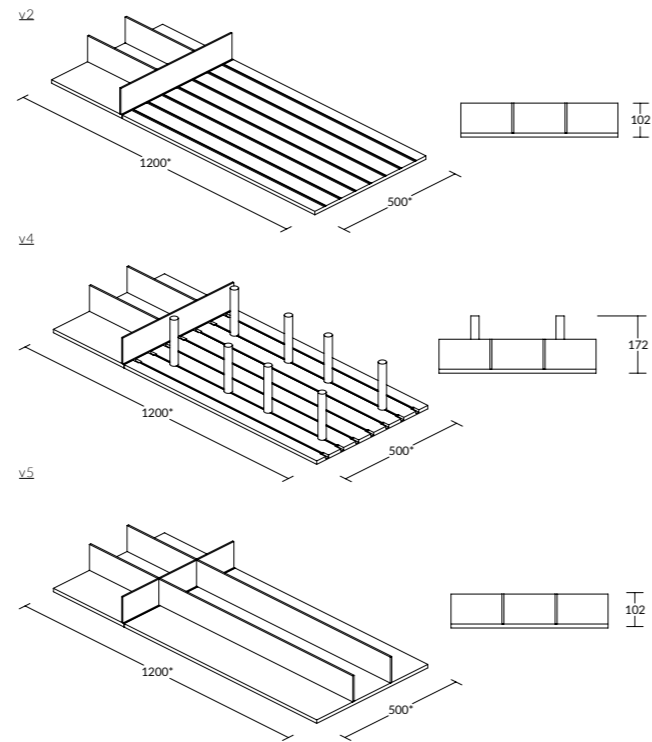

BOX ACCESSORI

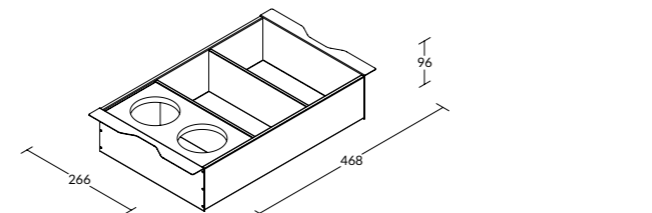

ACCESSORI DISPENSA

PORTABOTTIGLIE

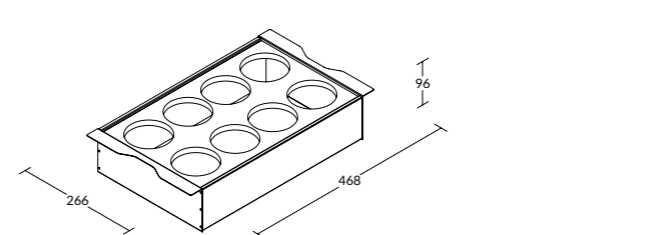

ACCESSORI DISPENSA

PORTABICCHIERI

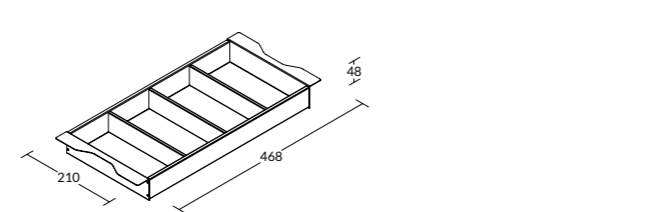

ACCESSORI DISPENSA

PORTAPIATTI

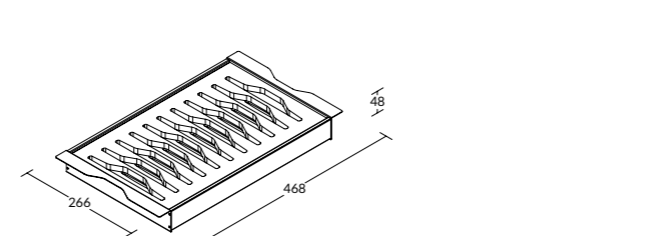

ACCESSORI DISPENSA

SET PASTA

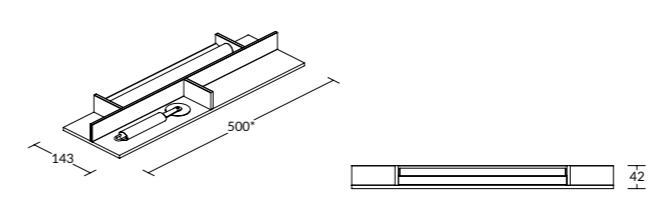

V1

PORTAFILM

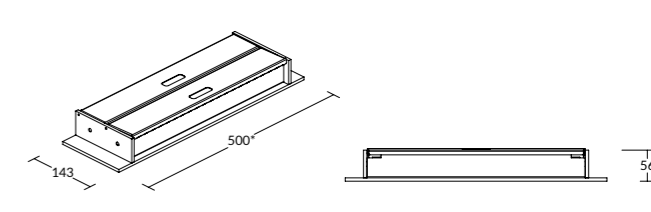

V1

PORTACIALDE

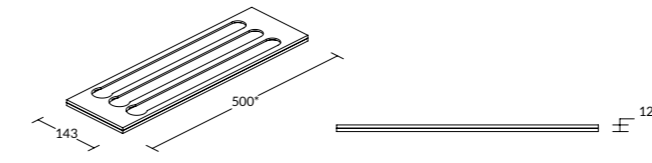

V1

DIVISORI T

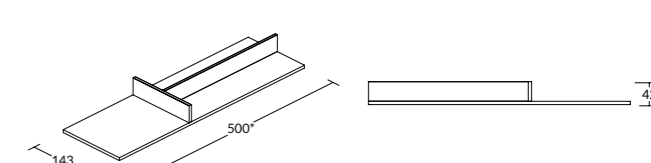

V1

PORTASPEZIE

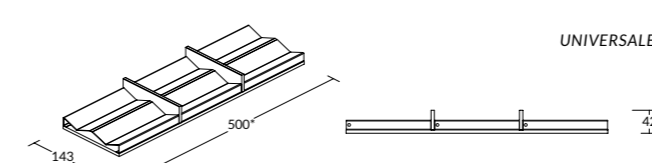

V1

PORTACOLTELLI

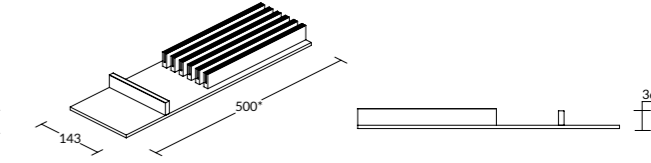

V1

PORTASPEZIE V1N

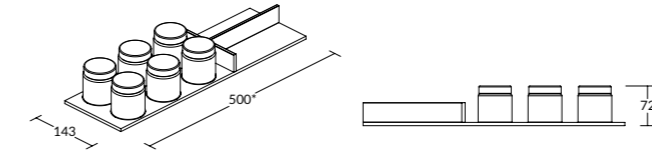

V1N

PORTASPEZIE V2

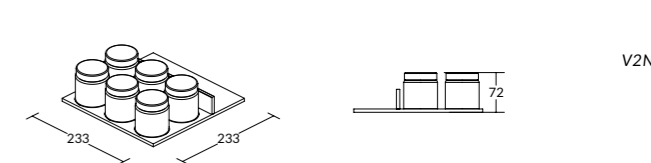

V2

PORTASPEZIE V1V

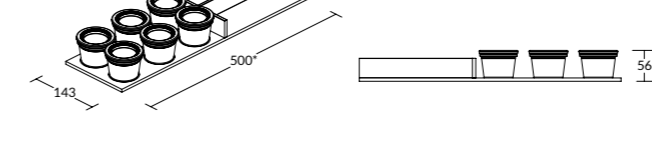

V1V

PORTASPEZIE V2V

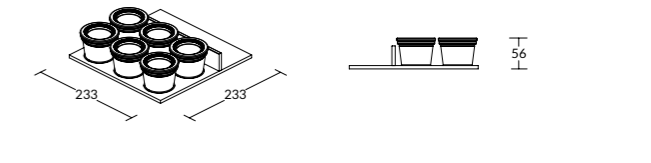

V2V

SET VINO

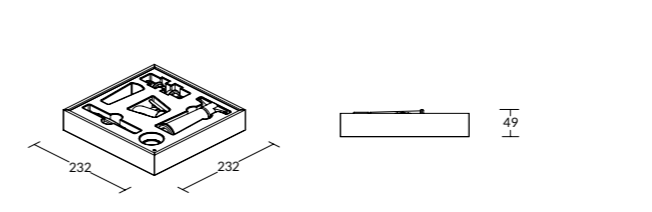

V2

TAGLIERE

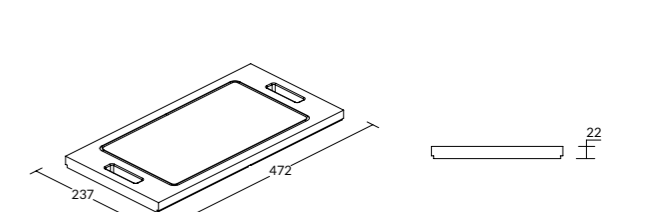

V2

SET COCKTAIL

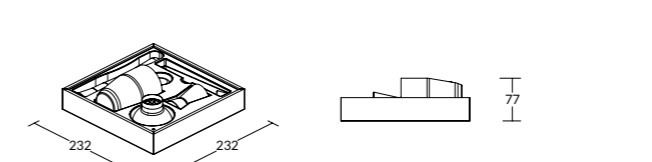

V2

SET CONDIMENTI

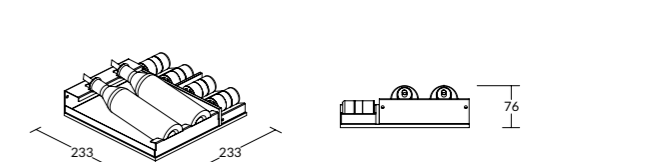

V2

NOMAD POSATE

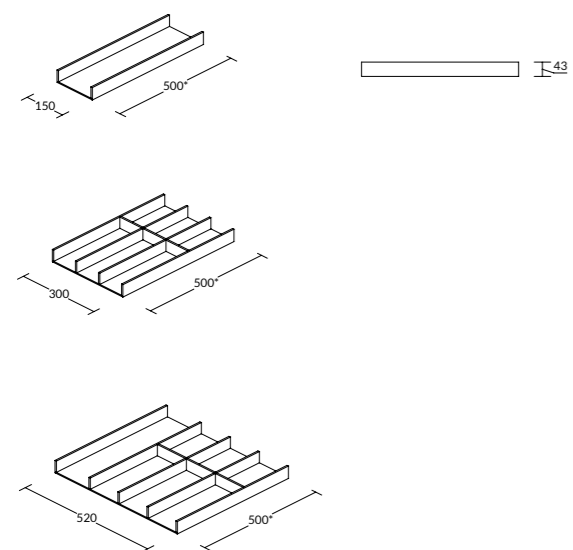

NOMAD DISPENSA

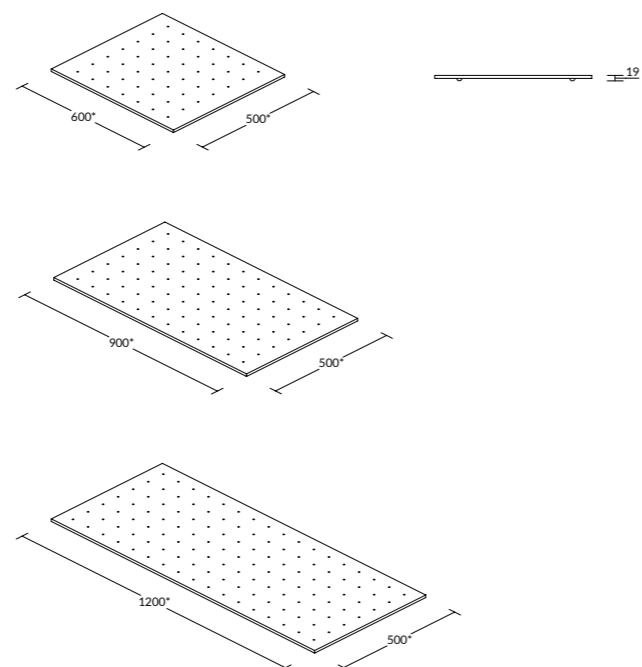

SISTEMA CASSETTO PORTAPOSATE

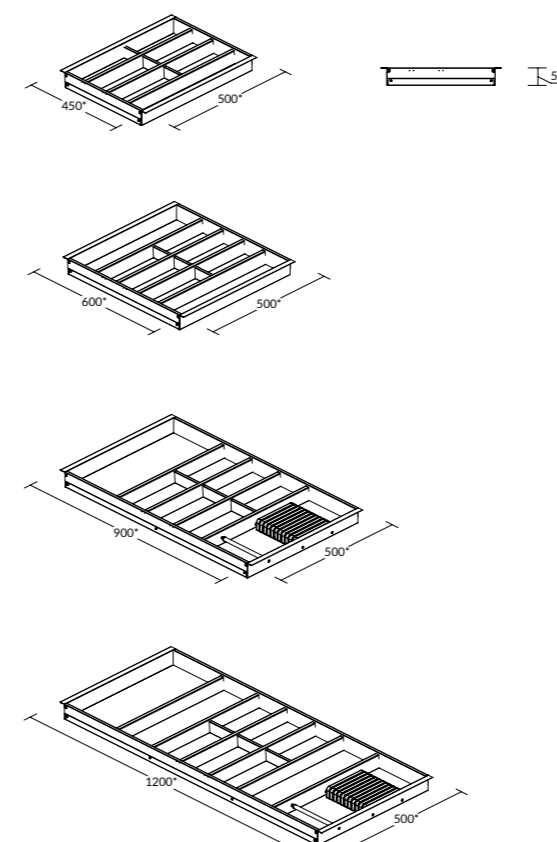

SISTEMA CASSETTO PORTAPIATTI

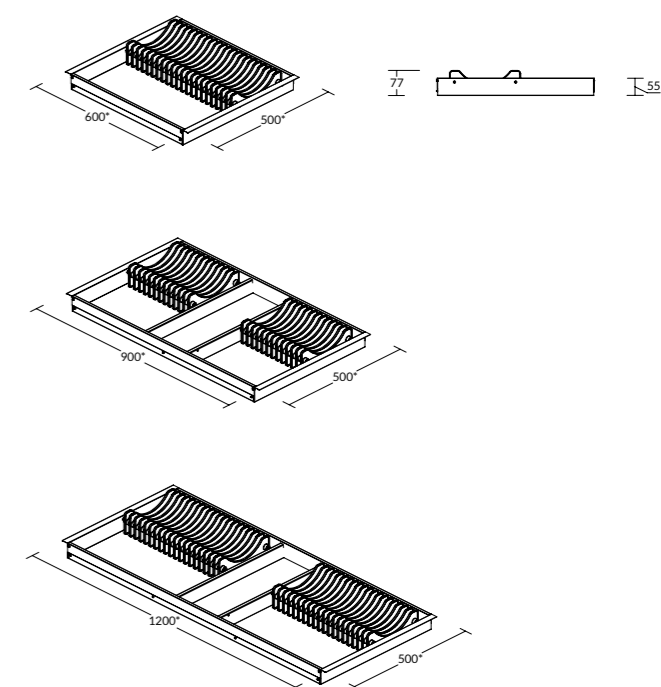

PORTA COLTELLI

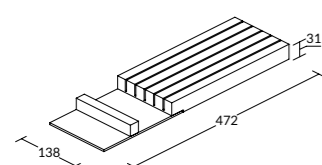

PORTASPEZIE

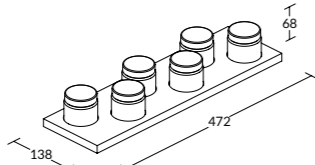

PORTAPELLICOLE

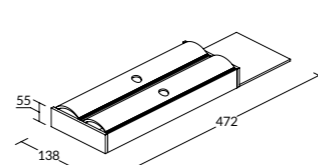

TAGLIERE

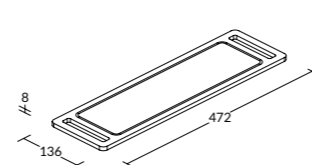

PORTA COPERCHI

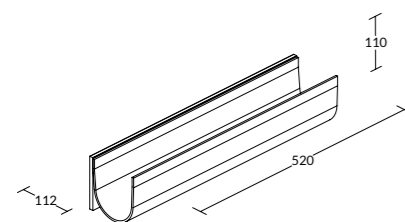

PORTA BOTTIGLIE

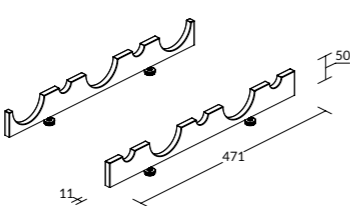

PORTAPIATTI

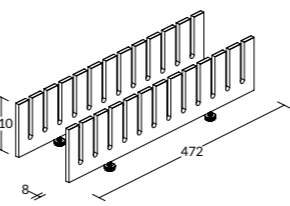

SET DIVISORI

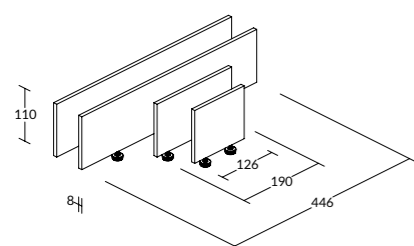

PORTAOGGETTI

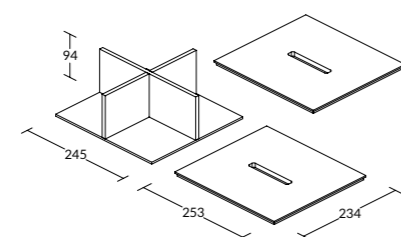

PORTA BARATTOLI

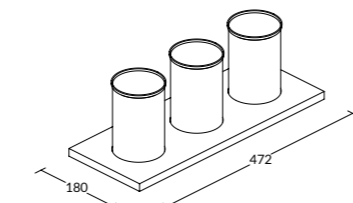

SET PILASTRINI

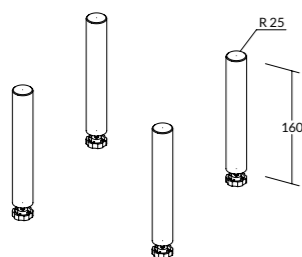

TECNOROCK POSATE

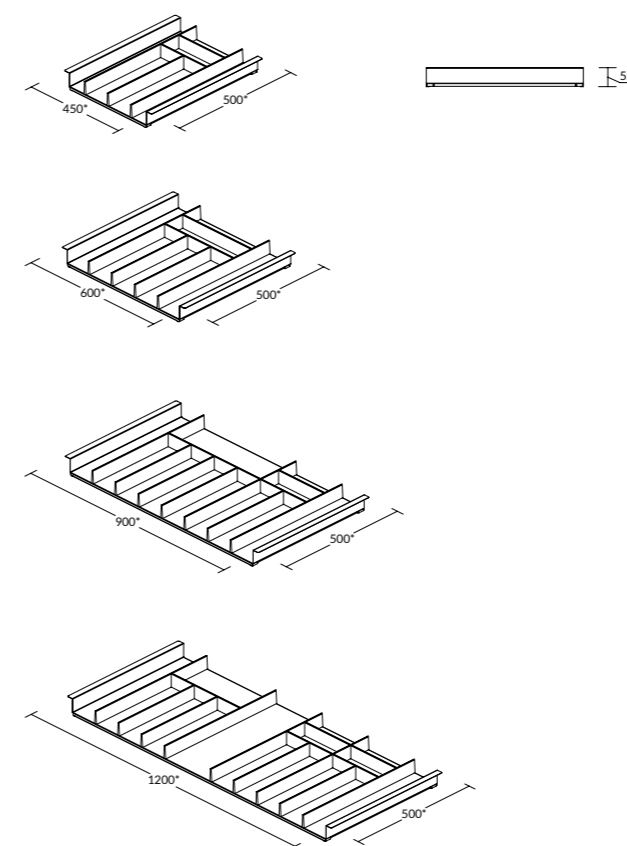

TECNOROCK DISPENSA

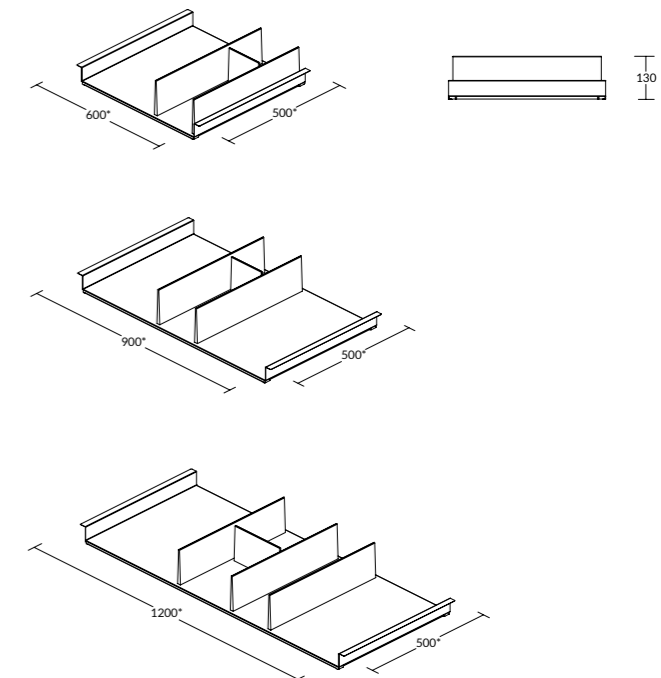



PORTASPEZIE      PORTAPELLICOLE      SET BARATTOLI

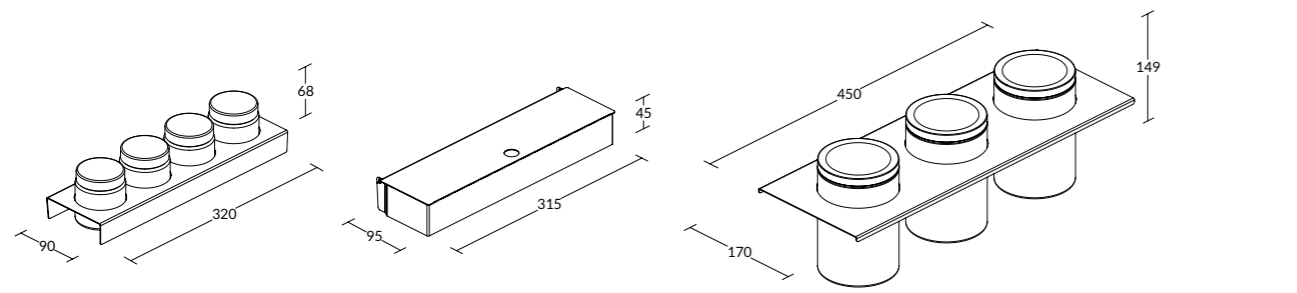

PORTAPIATTI      PORTACOLTELLI      CONTENITORE

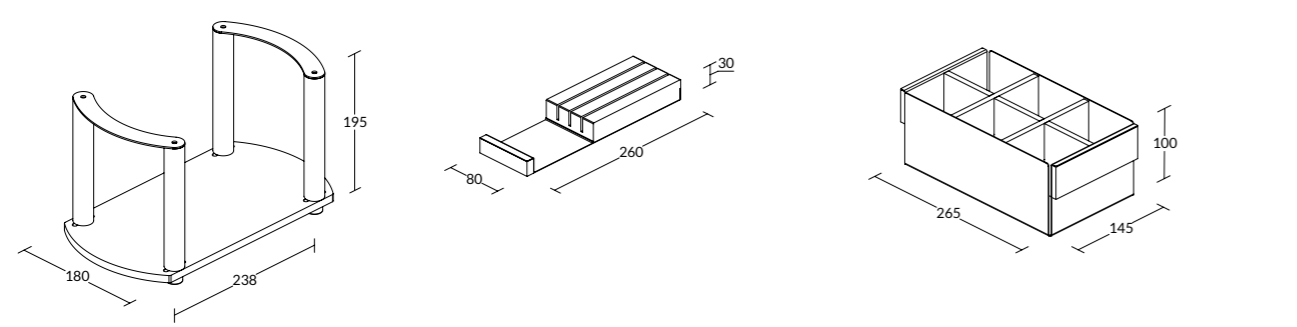

TAPPETINO

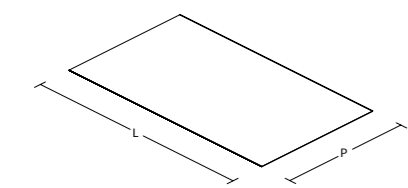

L = 369 - 519 - 669 - 819 - 969 - 1119  
P = 472 - 572

\* Le dimensioni si riferiscono alle misure nominali del cassetto. \* The dimensions refer to the nominal dimensions of the drawer.

## LINEA ACCESSORI BAGNO/ BATHROOM ACCESSORIES

---

TELAIO	93
FRAME	
CESTINO CON COPERCHIO	
WASTE WOOD BOX WITH LID	
DIVISORIO A CROCE	94
CROSS-SHAPED PARTITION	
CONTENITORE CON COPERCHIO	
WOOD BOX WITH LID	
PORTAOMBRETTI	95
EYESHADOW BOX	
PORTAMATITE	
EYE-PENCIL BOX	
PORTAROSSETTI	
LIPSTICK BOX	
TECHNICAL INFO	96



## X TELAIO

Il **Telaio** è l'elemento principale del prodotto che permette di generare la suddivisione degli spazi. Può essere impiegato con o senza accessori opzionali. All'interno di un singolo cassetto possono essere affiancati, a seconda delle dimensioni, due o più telai per una migliore organizzazione.

*The frame is the central element of the item, and ensures available space is broken down into smaller compartments. It may be used with or without optional accessories. Inside a single drawer two or more frames may be added, depending on size, for optimal allocation of space.*



## X CESTINO CON COPERCHIO

Contenitore alto, per cassetti con anta di altezza minima 24 cm. Può essere utilizzato per contenere oggetti di medie dimensioni, o come piccolo contenitore per l'immondizia.

*Tall container for drawers with min. 24 cm door height. It can be used to hold medium sized items, or as a small rubbish bin.*



## X DIVISORIO A CROCE

Accessorio per contenere elastici, mollette, anelli, piccoli oggetti, ecc.

*Accessory holding elastic bands, clips, rings, and knick-knacks.*



## X CONTENITORE CON COPERCHIO

Può essere usato per tenere fazzoletti, Kleenex, dischi di cotone, piccoli oggetti, ecc.

*It can be used to keep handkerchiefs, paper tissues, cotton wool pads, knick-knacks...*



COMPOSIZIONE ACCESSORI BAGNO PER 2 CASSETTI DA 90  
BATH ACCESSORIES COMPOSITION FOR 2 DRAWERS OF 90



COMPOSIZIONE ACCESSORI BAGNO PER 2 CASSETTI DA 90  
BATH ACCESSORIES COMPOSITION FOR 2 DRAWERS OF 90

## PORTAOMBRETTI

Grazie alla sua forma è adatto a riporre contenitori per il trucco di diverse dimensioni, così come cipria, fard, fondotinta, ecc.

*Its handy shape makes it ideal for storing make-up boxes in different sizes, as well as face powder, rouge, and foundation sets.*



## PORTAMATITE

Accessorio per matite per occhi, eyeliner, mascara, pennelli, ecc.

*Accessory for eye-pencils, eyeliners, mascara, brushes.*



## PORTAROSSETTI

Accessorio contenitore per smalto unghie, rossetti, gloss, ecc.

*Accessory for nail varnish, lipstick, and gloss.*



## TELAIO

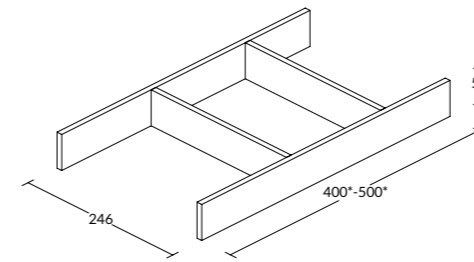

## DIVISORIO A CROCE

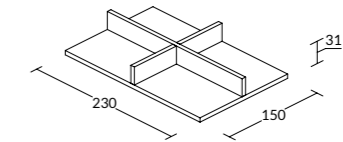

## CESTINO CON COPERCHIO

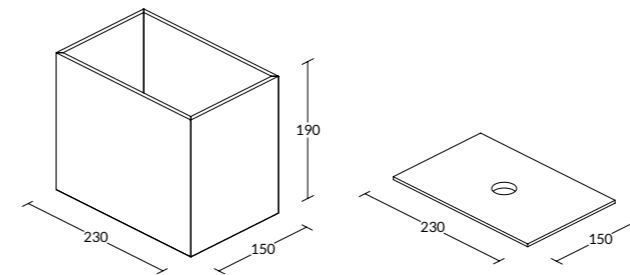

## CONTENITORE CON COPERCHIO

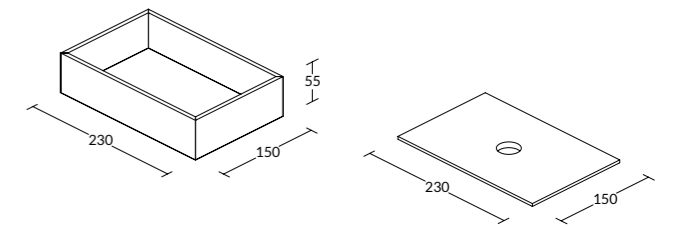

## PORTAOMBRETTI

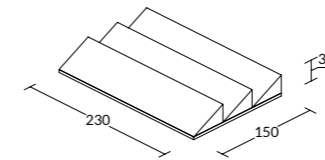

## PORTAMATITE

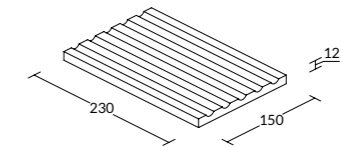

## PORTAROSSETTI

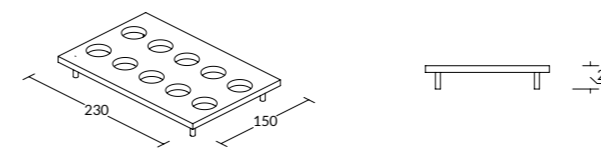

## ACCESSORI/ ACCESSORIES

---

TRAVERSA PER BASE PROFILO 18X10 <i>CROSSPIECE FOR BASE 18X10</i>	99
TRAVERSA PER BASE PROFILO 18X18 <i>CROSSPIECE FOR BASE 18X18</i>	
TRAVERSA PER BASE PROFILO 18X30 <i>CROSSPIECE FOR BASE 18X30</i>	
TRAVERSA PER BASE CON FISSAGGIO AL TOP <i>CROSSPIECE FOR BASE WITH ATTACHMENT TO TOP</i>	
TRAVERSA PER BASE CON PREMONTAGGIO <i>PRE-ASSEMBLED BASE CROSSBAR</i>	100
RIVESTIMENTO SOTTOLAVELLO CON GUARNIZIONI <i>SINK BOTTOM COVERING WITH SEALING PROFILE</i>	
RIVESTIMENTO SOTTOLAVELLO <i>SINK BOTTOM COVERING</i>	
RIVESTIMENTO SOTTOLAVELLO PER MOBILE AD ANGOLO <i>COVERING FOR CORNER UNITS</i>	

**X** TRAVERSA PER BASE  
PROFILO 18X10

Realizzato in alluminio anodizzato.  
E' disponibile nelle misure per mobile da \*40 a \*120 cm di larghezza.

*Made of anodized aluminium.  
It is available in cabinet sizes from \*40 a \*120 cm wide.*



**X** TRAVERSA PER BASE  
PROFILO 18X18

Realizzato in alluminio anodizzato.  
E' disponibile nelle misure per mobile da \*40 a \*120 cm di larghezza.

*Made of anodized aluminium.  
It is available in cabinet sizes from \*40 a \*120 cm wide.*



**X** TRAVERSA PER BASE  
PROFILO 18X30

Realizzato in alluminio anodizzato.  
E' disponibile nelle misure per mobile da \*40 a \*120 cm di larghezza.

*Made of anodized aluminium.  
It is available in cabinet sizes from \*40 a \*120 cm wide.*



**X** TRAVERSA PER BASE  
CON FISSAGGIO AL TOP

Realizzato in alluminio anodizzato.  
E' disponibile nelle misure per mobile da \*40 a \*120 cm di larghezza.

*Made of anodized aluminium.  
It is available in cabinet sizes from \*40 a \*120 cm wide.*



**X** TRAVERSA PER BASE  
CON PREMONTAGGIO

Realizzato in alluminio anodizzato.  
E' disponibile nelle misure per mobile da \*40 a \*120 cm di larghezza.

*Made of anodized aluminium.  
It is available in cabinet sizes from \*40 a \*120 cm wide.*



**X** RIVESTIMENTO SOTTOLAVELLO  
CON GUARNIZIONI

In alluminio verniciato con spessore 0,5 mm.  
E' disponibile nelle misure per mobile da \*40 a \*120 cm di larghezza.  
Viene realizzato su disegno del cliente.

*In painted aluminium with 0.5 mm thickness.  
It is available in cabinet sizes from \*40 a \*120 cm wide.  
It is made to customer's drawing.*



**X** RIVESTIMENTO  
SOTTOLAVELLO

In alluminio verniciato con spessore 0,5 mm.  
E' disponibile nelle misure per mobile da \*40 a \*120 cm di larghezza.  
Viene realizzato su disegno del cliente.

*In painted aluminium with 0.5 mm thickness.  
It is available in cabinet sizes from \*40 a \*120 cm wide.  
It is made to customer's drawing.*



**X** RIVESTIMENTO SOTTOLAVELLO  
PER MOBILE AD ANGOLO

In alluminio verniciato con spessore 0,5 mm.  
Viene realizzato su disegno del cliente.

*In painted aluminium with 0.5 mm thickness.  
It is made to customer's drawing.*



---

---

---

---

---

---

---

---

---

---

---

---

---

---

---

---

---

---

---

---

**Tecnoinox srl**  
20825 Barlassina (MB), Italia  
via Longoni, 112/114  
tel. +39.0362.563327  
fax +39.0362.557966

[www.tecnoinoxsrl.it](http://www.tecnoinoxsrl.it)  
[contact@tecnoinoxsrl.it](mailto:contact@tecnoinoxsrl.it)



