

accessori

Acropoli
 Sezgin Aksu
 Angelotti & Cardile
 Claudio Bellini
 Chiara Bevegni
 Claus Breinholt
 Michele De Lucchi
 Graziano Friscione
 Giulio Iacchetti
 Caimi Lab
 Raffaello Manzoni
 Matteo Ragni
 Marc Sadler
 Silvia Suardi
 Id Vision

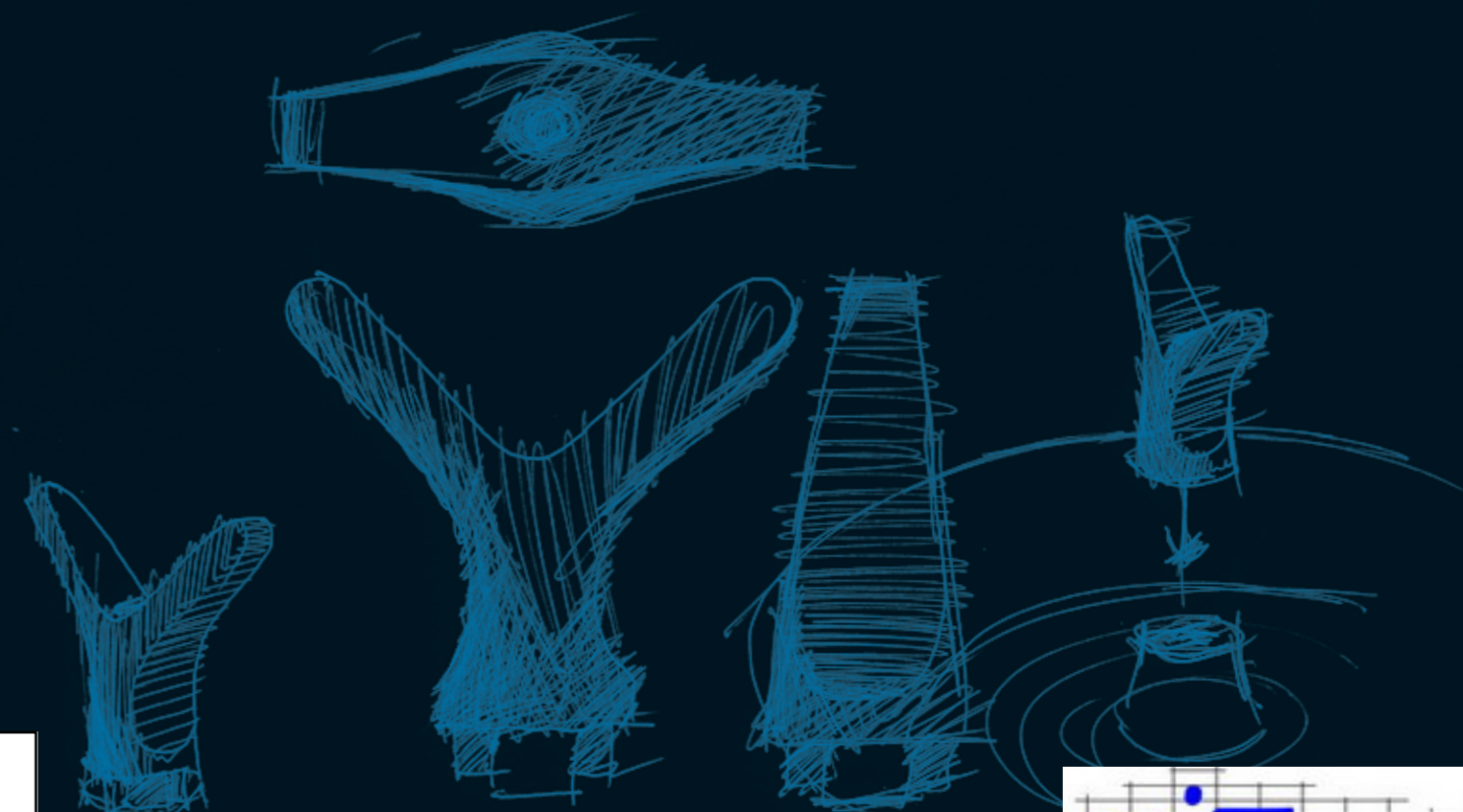

Witteveen Projectinrichting
 Ouderkerk a/d Amstel
 Tel: 020 - 496 5030
 Fax: 020 - 496 3052
 info@witteveen.nl
 www.project-inrichting.nl





1695 (GA)
 ø 32 x H 165 cm

1696 (GA)
 ø 32 x H 165 cm

1694 (GA)
 ø 32 x H 80 cm

1692 (GA)
 ø 32 x H 60 cm



I→La linea di complementi d'arredo direzionali Battista è composta da un appendiabiti, disponibile anche nella versione con portaombrelli, da un posacenere da pavimento, da un posacenere/portaoggetti da tavolo, da un portaombrelli e da un sistema di colonnine con cordoni o con nastro estensibile per la delimitazione degli spazi. Tutti gli articoli sono in alluminio pressofuso ed acciaio verniciato, mentre le basi - caratterizzate da un design assolutamente particolare - sono in ghisa verniciata. GB→Battista is a line of executive furniture fittings including a coat-stand, available also with umbrella ring, a floor ashtray, a table ashtray/object-holder, an umbrella-stand and a system of barrier stanchions and ropes. All items are in die cast aluminium and epoxy painted steel, while bases - marked by a most peculiar design - are in painted cast iron. F→La gamme d'accessoires pour bureau de direction Battista est formée d'un portemanteau, disponible aussi dans le modèle avec porte-parapluies, d'un cendrier de sol, d'un cendrier/porte-objet de table, un porte-parapluies et un système de colonnettes avec câbles ou rubans extensibles pour délimiter l'espace. Tous les articles sont en fusion d'aluminium et acier peint, tandis que les bases - caractérisées par un design tout à fait particulier - sont en fonte peinte. D→Die Design Linie Battista besteht aus einem Kleiderständer, welcher in einer Ausführung auch mit Schirmständer erhältlich ist, einem Standaschenbecher, einem Aschenbecher/Objektsablage, einem Schirmständer und Absperrpfosten mit Kordeln oder ausziehbarem Gurt zur Abgrenzung von Räumen. Die Elemente bestehen aus Aluminium-Druckguss und beschichtetem Stahl. Die Basisteile, mit Sonderdesign, sind aus beschichtetem Gusseisen gefertigt. E→La línea de complementos de decoración direccionales Battista está compuesta por un perchero, del que existe también el modelo con paraguero, por un cenicero de pie, por un cenicero/portaobjetos de mesa, por un paraguero y por un sistema de pequeñas columnas con cordones o cinta retractil para delimitar los espacios. Todos los artículos son realizados en aluminio moldeado a presión y en acero pintado, mientras que las bases - caracterizadas por un design absolutamente singular - son en hierro fundido pintado.



1695 (N)
 ø 32 x H 165 cm

1696 (N)
 ø 32 x H 165 cm

1694 (N)
 ø 32 x H 80 cm

1692 (N)
 ø 32 x H 60 cm

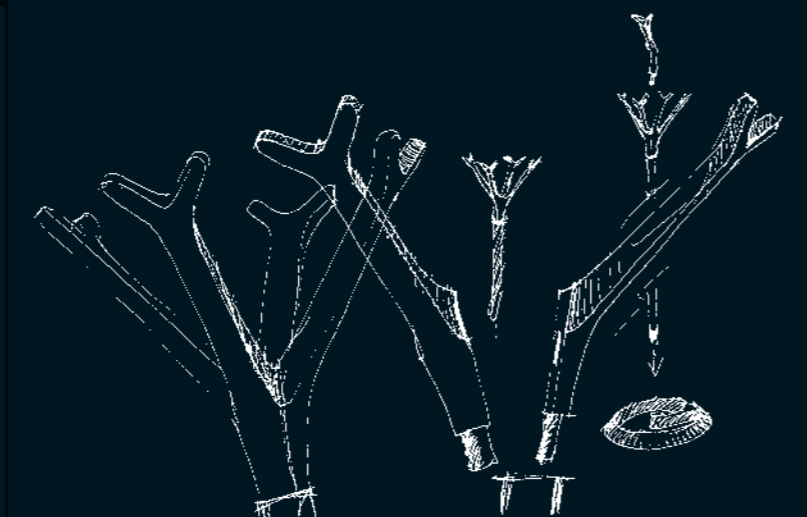
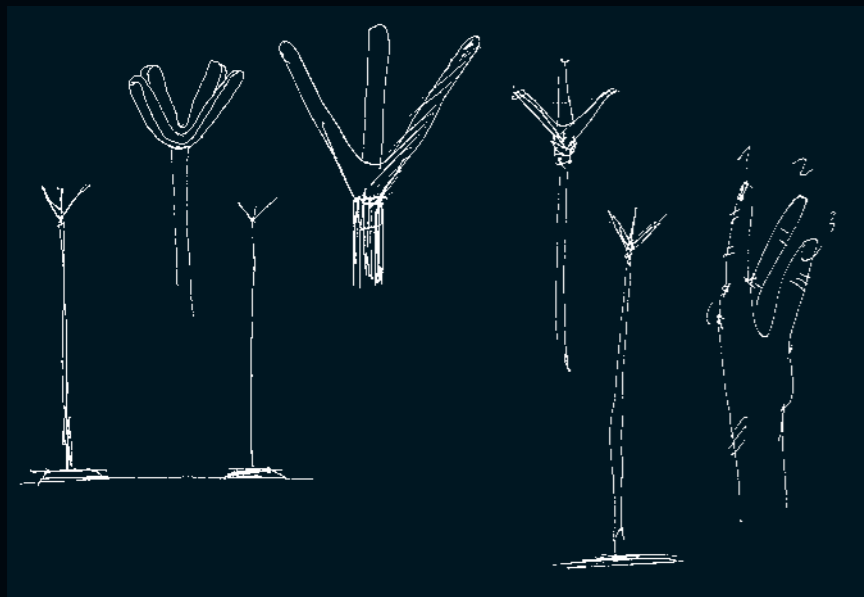

1691
ø 32 x H 12,5 cm



1640 (GA)
ø 32 x H 180 cm

1641
1642-B
1642-AR
1642-BL
L 95 x H 167,5 cm

1640 (GA)
ø 32 x H 180 cm

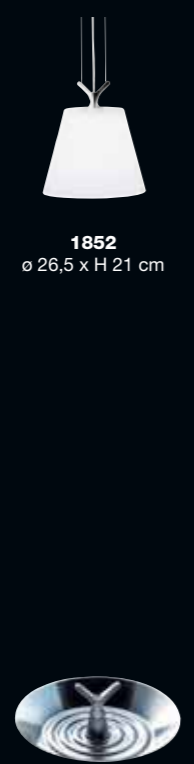

1852
ø 26,5 x H 21 cm



1853
ø 35,5 x H 28,5 cm



1851
ø 32 x H 56 cm



1712-GA
ø 35,5 H 175 cm



1714-GA
ø 32 H 180 cm



1696 (GA)
1696 (N)
ø 32 x H 165 cm



1695 (GA)
1695 (N)
ø 32 x H 165 cm



1694 (GA)
1694 (N)
ø 32 x H 80 cm

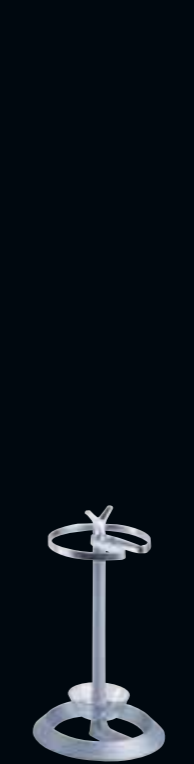

1692 (GA)
1692 (N)
ø 32 x H 60 cm



1680 (GA)
1680 (N)
ø 32 x H 103 cm

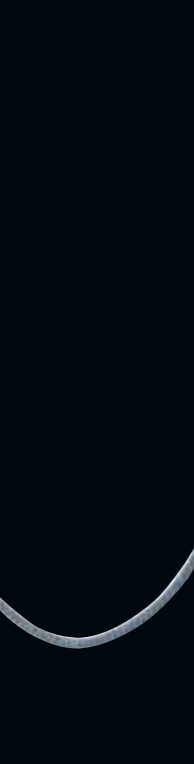

1685 (GR)
1685 (R)
L 180 cm



1680 (GA)
1680 (N)
ø 32 x H 103 cm



1670-GAN
1670-GABL
ø 32 x H 100 cm



1670-GAN
1670-GABL
ø 32 x H 100 cm



La Triennale di Milano (Italy)

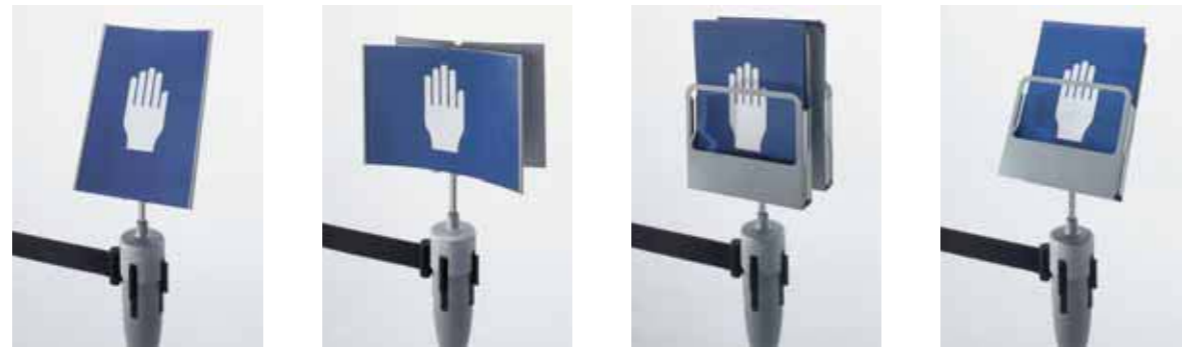

I→La colonnina con nastro estensibile della serie Battista è ottenuta mediante una sofisticata lavorazione del tubolare d'acciaio che viene conifcato per poter passare da un \varnothing 70 mm ad un \varnothing 32 mm. Questa tecnologia permette di realizzare una colonnina dalla forma sinuosa, esile nella parte inferiore per ridurre l'impatto visivo.
GB→The small column with retractable tape of the line Battista is obtained through a sophisticated working of the steel tubular, which is cone-shaped to change from a 70 mm dia to 32 mm dia. This technology allows to carry out a sinuous column; thin in the lower part for a lower visual impact.
F→La colonnette avec ruban extensible de la série Battista est obtenue au moyen d'un travail sophistiqué du tubulaire d'acier qui devient conique pour pouvoir changer de \varnothing 70 mm à \varnothing 32 mm. Cette technologie permet de réaliser une petite colonne à la forme sinueuse; mince dans la partie inférieure pour réduire l'impact visuel.
D→Die kleine Säule mit ausziehbarem Band der Serie Battista wird durch eine innovative Bearbeitung des Stahlrohrs erhalten, welches eingerammt wird, um von einem anfänglichen Durchm. 70 mm in einen mit 32 mm zu passen. Diese Technologie ermöglicht es, eine Säule mit gewundener Form zu erzeugen, der im unteren Teil schlank ist, und dadurch eleganter wirkt.
E→La columna con cinta extensible de la serie Battista se obtiene mediante un sofisticado proceso del tubo de acero que se conifica para poder pasar de un \varnothing 70 mm a un \varnothing 32 mm. Esta tecnología permite realizar una columna de forma sinuosa, delgada en la parte inferior, para reducir el impacto visual.



Nuova Fiera Milano - Rho (Italy)



"The Keith Haring Show", La Triennale di Milano (Italy)



La Triennale di Milano (Italy)



"The Keith Haring Show", La Triennale di Milano (Italy)



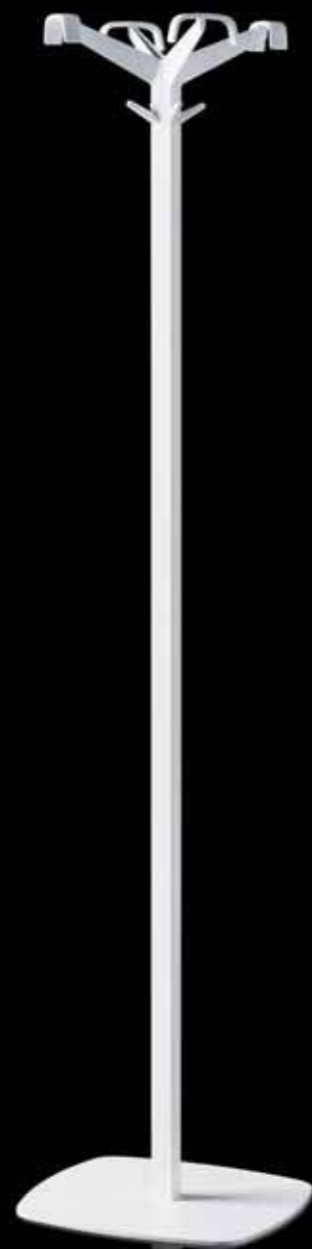

1488-BO
35 x 35 x H 164 cm

I→Appendiabiti a piantana con tubo centrale a sezione quadrata e base realizzati in acciaio verniciato con polveri epossidiche finitura bianco opaco. La testa è realizzata in policarbonato finitura bianco opaco. GB→Coat stand with a central, square-section tube and base carried out in powder-coated steel, mat white finish. The head is in mat white polycarbonate. F→Portemanteau avec tube central à section carrée et base réalisés en acier peint époxy, finition blanc mat. La tête est en polycarbonate, finition blanc mat. D→Kleiderständer mit mittlerem Ständer mit quadratischem Grundriss und Basis aus mit Epoxidpulver beschichtetem Stahl, weiss mattes Finish. Der Kopf ist aus Polycarbonat, mit weiß-mattem Finish. E→Percheros de pie con tubo central de sección cuadrada y base de acero recubierto con polvo epoxi acabado blanco mate. La cabeza es de policarbonato acabado blanco mate.



I→Appendiabiti a piantana con struttura in acciaio verniciato con polveri epossidiche finitura bianco opaco. La testa è realizzata in policarbonato trasparente, l'anello portaombrelli e la vaschetta raccogliogocce sono in tecnopolimero finitura bianco opaco. GB→Coat stand with powder-coated steel structure, mat white finish. The head is in transparent polycarbonate, the umbrella ring and drip tray are in high-tech polymer, mat white finish. F→Portemanteau avec structure en acier peint époxy en blanc mat. La tête est réalisée en polycarbonate transparent, l'anneau porte-parapluies et le réceptacle sont en technopolymère blanc mat. D→Kleiderständer mit Stahlstruktur, beschichtet mit Epoxidpulver, weiß-mattes Finish. Der Kopf ist aus transparentem Polycarbonat, der Schirmhalterungsring und das Abtropfbecken sind aus Technopolymer mit weiß-mattem Finish. E→Percheros de pie con estructura de acero recubierto con polvo epoxi acabado blanco mate. La cabeza es de policarbonato transparente; el anillo paraguero y el recogeaguas son de tecnopolímero acabado blanco mate.

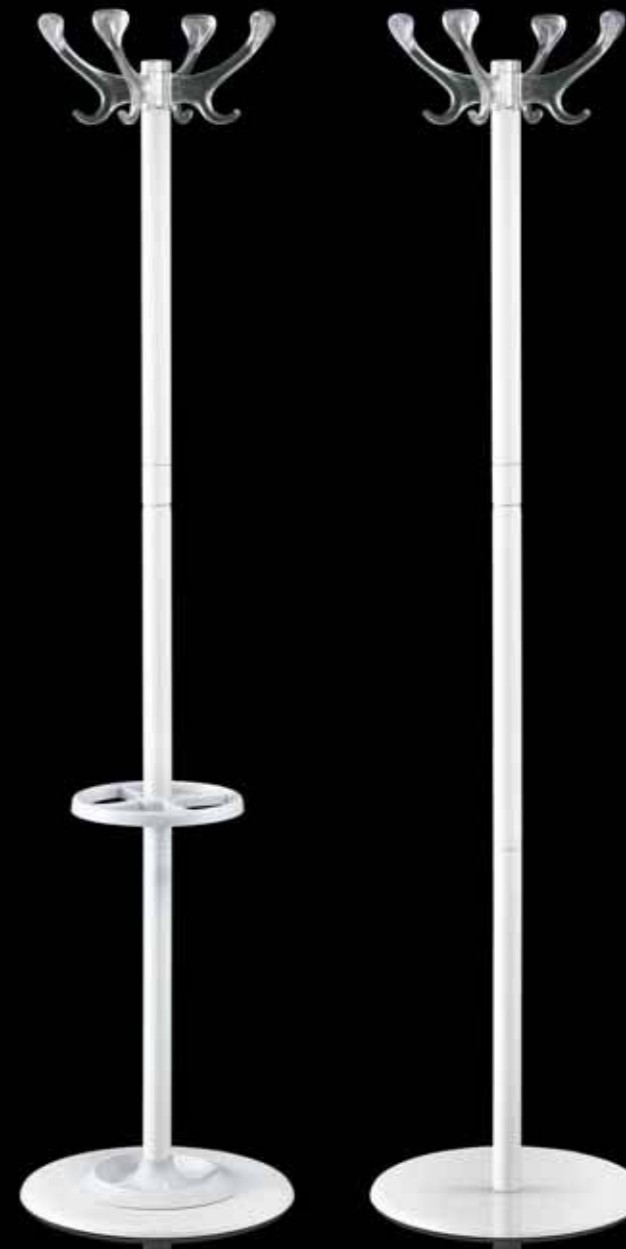

1476-TBO
ø 39 x H 165 cm

I→Portaombrelli asportabile.
GB→Removable umbrella-holder.
F→Porte-parapluies emportable.
D→Demontierbarer Schirmhalter.
E→Paraguero exportable.



1476-TBO
ø 39 x H 165 cm





I→Appendiabiti a piantana con struttura in acciaio verniciato con polveri epossidiche. La testa è realizzata in policarbonato nero, trasparente, blu trasparente o verniciato grigio argento. L'anello portaombrelli e la vaschetta raccogli gocce sono in tecnopolimero.
GB→Coat stand with structure in epoxy painted steel. The head is in polycarbonate, transparent, black, transparent blue or painted silver grey. The umbrella ring and the drip-tray are in high-tech polymer.
F→Portemanteau, structure en acier peint époxy. La tête est réalisée en polycarbonate noir, transparent, bleu transparent ou peint gris argenté. L'anneau porte-parapluies et le réceptacle sont en techno-polymère.
D→Kleiderständer mit einer Struktur aus mit Epoxidpulver beschichtetem Stahl. Der Kopf besteht aus schwarzem Polykarbonat, transparent, blau transparent oder silbergrau beschichtet. Der Schirmständering und die Tropfenwanne sind aus Technopolymer hergestellt.
E→Perchero de pie con estructura de acero, recubierto con polvo epoxi. El cabezal está realizado en policarbonato negro, transparente, azul transparente o recubierto gris plata. El aro porta-paraguas y la bandeja recoge gotas son de tecnopolímero.

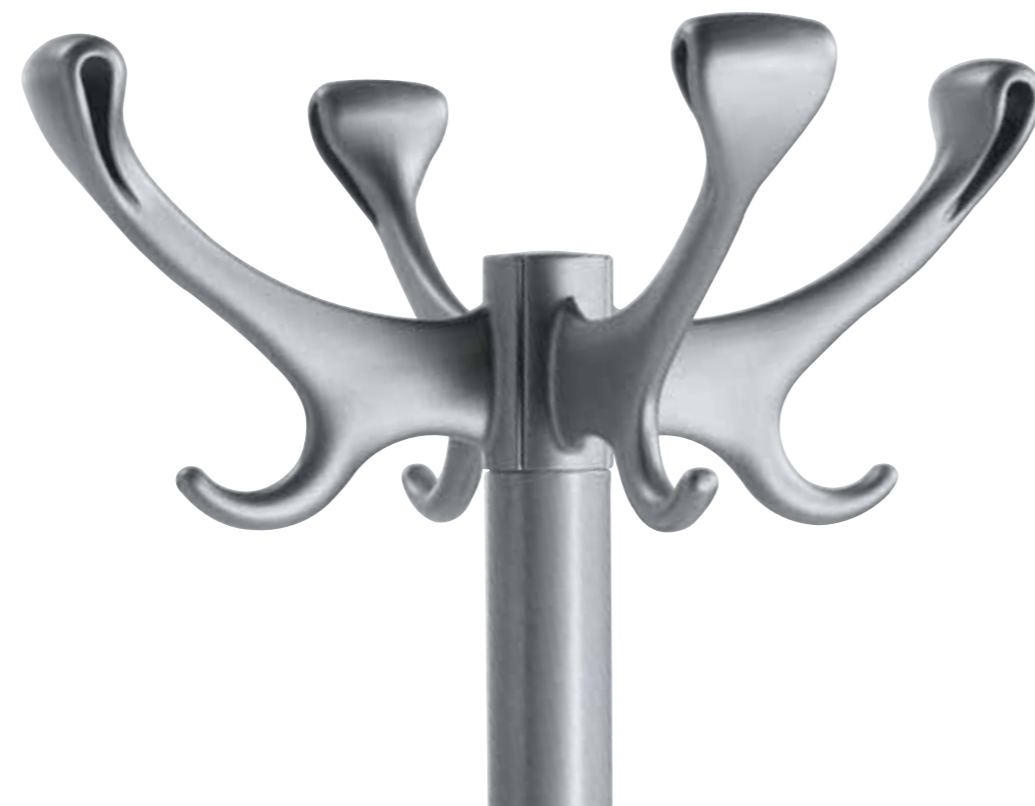
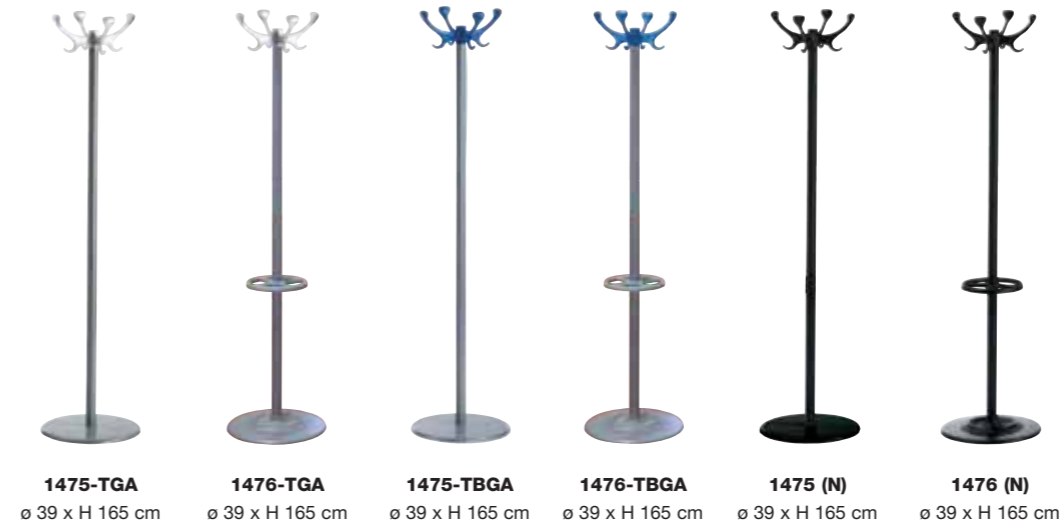



1485-N ø 39 x H 172 cm
1485-GA ø 39 x H 172 cm
1485-TGA ø 39 x H 172 cm

I→Portaombrelli asportabile. GB→Removable umbrella-holder. F→Porte-parapluies emportable. D→Demontierbarer Schirmhalter. E→Paragüero exportable.



I→Portabiti a piantana con struttura in acciaio verniciato con polveri epossidiche, colore nero o grigio argento. La testa è realizzata in policarbonato nero, grigio o trasparente. L'anello portaombrelli e la vaschetta raccogliogocce sono in tecnopolimero nero o grigio. GB→Coat stand with stem in epoxy painted steel, black or silver grey. The head is available in black, grey or transparent polycarbonate. The umbrella ring and the drip tray are in black or grey high-tech polymer. F→Portemanteau avec corps en acier peint en époxy, noir ou gris argenté. Tête en polycarbonate noir, gris ou transparent. Anneau porte-parapluies et réceptacle en technopolymère noir ou gris. D→Garderobenständer aus mit Epoxypulvern beschichtetem Stahl. Lieferbar in den Ausführungen schwarz oder silbergrau. Kopfteil aus schwarzem, grauem oder transparentem Polycarbonat. Schirmhalterung und Wassersammelbecken aus schwarzem oder grauem Technopolymer. E→Perchero de pie con estructura en acero pintado con polvos epoxídicos, color negro o gris plata. La cabecera está realizada en policarbonato negro, gris o transparente. El aro paragüero y la cubeta recoge aguas son en tecnopolímero negro o gris.



1515-C ø 39 x H 166 cm
1515 (N) ø 39 x H 166 cm
1515-GA ø 39 x H 166 cm

I→Portaombrelli asportabile. GB→Removable umbrella-holder. F→Porte-parapluies emportable. D→Demontierbarer Schirmhalter. E→Paragüero exportable.

I→Portabiti a piantana con struttura in acciaio cromato o verniciato con polveri epossidiche. Base e testa in acciaio verniciato con polveri epossidiche con nucleo centrale in tecnopolimero nero o policarbonato trasparente. Anello portaombrelli e vaschetta raccogliogocce in tecnopolimero. GB→Coat stand with stem in chrome-plated or epoxy painted steel. Base and head in epoxy powder painted steel. Central hub in black high-tech polymer or transparent polycarbonate. Umbrella ring and drip tray in high-tech polymer. F→Portemanteau avec corps en acier chromé ou peint en époxy. Base et tête en acier peint en époxy, avec noyau central en techno-polymère noir ou polycarbonate transparent. Anneau porte-parapluies et réceptacle en technopolymère. D→Kleiderständer mit Struktur aus verchromtem Stahl oder aus mit Epoxypulvern beschichtetem Stahl. Basis und Kopfteil aus mit Epoxypulvern beschichtetem Stahl; das Kernteil besteht aus schwarzem Kunststoff oder transparentem Polycarbonat. Schirmhalterung und Wassersammelbecken aus Technopolymer. E→Perchero de pie con estructura en acero cromado o pintado con polvos epoxídicos. Base y parte superior en acero pintado con polvos epoxídicos con núcleo central en tecnopolímero negro o policarbonato transparente. Aro paragüero y cubeta recoge aguas en tecnopolímero.



1515-TGA
 ø 39 x H 166 cm





I→Portabiti a piantana realizzati con struttura in acciaio verniciato con polveri epossidiche o con fusto cromato. Testa, anello portaombrelli e vaschetta raccogli-gocce in tecnopolimero nero.
GB→Coat stand with stem in powder-coated or chrome-plated steel. Head, umbrella ring and drip tray in black high-tech polymer.
F→Portemanteau avec corps en acier peint en époxy ou avec tige chromé. Tête, anneau porte-parapluies et réceptacle en technopolymère noir. **D**→Garderobenständer aus mit Epoxypulvern beschichtetem oder verchromtem Stahl. Kopf, Schirmhalterung und Wassersammelbecken aus schwarzem Technopolymer.
E→Perchero de pie con estructura en acero cromado o pintado con polvos epoxídicos. Cabecera, aro paraguero y cubeta recoge aguas en tecnopolímero negro.

I→Portaombrelli asportabile.
GB→Removable umbrella-holder.
F→Porte-parapluies emportable.
D→Demontierbarer Schirmhalter.
E→Paraguero exportable.



I→Portabiti a piantana con struttura in acciaio cromato o verniciato con polveri epossidiche. Testa in tecnopolimero nero. Anello portaombrelli e vaschetta raccogli-gocce in tecnopolimero nero.
GB→Coat stand with stem in chrome-plated or powder-coated steel. Head in black high-tech polymer. Umbrella ring and drip tray in black high-tech polymer. **F**→Portemanteau avec corps en acier chromé ou peint en époxy. Tête en techno-polymère noir. Anneau porte-parapluies et réceptacle en techno-polymère noir.
D→Kleiderständer mit Struktur aus verchromtem Stahl oder aus mit Epoxypulvern beschichtetem Stahl. Kopfteil aus schwarzem Technopolymer. Regenschirmring und untere Tropfenschale aus schwarzem Technopolymer. **E**→Perchero de pie con estructura en acero cromado o pintado con polvos epoxídicos. Cabecera en tecnopolímero negro. Aro paraguero y cubeta recoge aguas en tecnopolímero negro.

I→Portaombrelli asportabile.
GB→Removable umbrella-holder.
F→Porte-parapluies emportable.
D→Demontierbarer Schirmhalter.
E→Paraguero exportable.





I→Portabiti a piantana con struttura in acciaio verniciato lucido con polveri epossidiche. Testa in policarbonato trasparente, cava all'interno. Anello portaombrelli e vaschetta raccogliogocce in tecnopolimero lucido. GB→Coat stand with glossy epoxy powder coated steel structure. Transparent polycarbonate top, internally hollow. Umbrella holder ring and drip tray in glossy high-tech polymer. F→Portemanteau sur pied avec structure en acier peint en époxy, finition lucide. Tête en polycarbonate transparent, creuse à l'intérieur. Anneau porte-parapluies et réceptacle en technopolymère brillant. D→Kleiderständer mit Stahlgestell, glanzlackiert mit Epoxidpulver. Oberteil aus transparentem Polycarbonat, innen hohl. Schirmhalterungsring und Tropfenwanne aus glänzendem Technopolymer. E→Perchero de pie con estructura de acero recubierto brillante con polvo epoxi. Cabeza de policarbonato transparente, hueca por dentro. Anillo portaparaguas y recipiente recoge-aguas de tecnopolimero brillante.

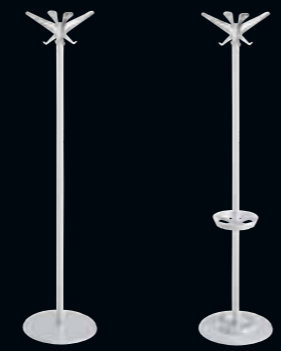

1486-BT
ø 39 x H 167 cm



I→Portaombrelli asportabile. GB→Removable umbrella-holder. F→Porte-parapluies emportable. D→Demontierbarer Schirmhalter. E→Paragüero exportable.



I→Portabiti a piantana con struttura in acciaio verniciato lucido con polveri epossidiche. Testa, anello portaombrelli e vaschetta raccogliogocce in tecnopolimero lucido. GB→Coat stand with structure in glossy powder-coated steel. Head, ring, umbrella ring and drip-tray in glossy high-tech polymer. F→Portemanteau avec corps en acier peint époxy, finition lucide. Tête, anneau portemanteau et réceptacle en technopolymère brillant. D→Kleiderständer, Gestell aus mit Epoxidpulver glänzend beschichtetem Stahl. Kopf, Ring, Schirmständer und Tropfwanne aus glänzendem Technopolymer. E→Perchero de pie con estructura de acero recubierto brillante con polvos epoxi. Cabeza, anillo paragüero y recoge-aguas de tecnopolimero brillante.



1486-B
ø 39 x H 167 cm

I→Portaombrelli asportabile. GB→Removable umbrella-holder. F→Porte-parapluies emportable. D→Demontierbarer Schirmhalter. E→Paragüero exportable.



1486-N
ø 39 x H 167 cm



I→Appendiabiti da parete componibile. Il tubo di sostegno è realizzato in acciaio cromato a sezione ovale, i ganci e gli elementi di fissaggio a muro sono realizzati in tecnopolimero nero, bianco lucido o in policarbonato trasparente cavo all'interno. Per una migliore facilità d'uso i ganci possono essere fissati, oppure scorrere liberamente lungo la barra. GB→Modular wall-mounted coat rail. The supporting tube is in chrome-plated steel, oval section, hooks and supports in black or glossy white high-tech polymer or in transparent polycarbonate, internally hollow. For an easier use, the hooks can be fastened or run along the bar freely. F→Portemanteau mural par éléments. Le tube de support est en acier chromé à section ovale, les crochets et les éléments de fixation murale sont en technopolymère noir ou blanc brillant ou en polycarbonate transparent, creux à l'intérieur. Pour faciliter l'emploi, les crochets peuvent être fixés ou glisser librement sur la barre. D→Kombinierbare Wand-Garderobe. Der Rohrständer ist aus verchromtem Stahl mit ovalem Durchschnitt hergestellt, die Hacken und die Befestigungselemente an der Mauer sind aus Technopolymer, glänzend weiß, schwarz oder transparentem Polycarbonat, innen hohl. Für den bequemeren Gebrauch können sie befestigt werden oder frei der Stange entlang verschoben werden. E→Perchero de pared componible. El tubo de sujeción es de acero cromado de sección oval, los ganchos y los elementos de sujeción a la pared son de tecnopolimero negro o blanco brillante o de policarbonato transparente, hueco por dentro. Para una mayor facilidad de uso, los ganchos pueden fijarse o moverse sueltos a lo largo de la barra.

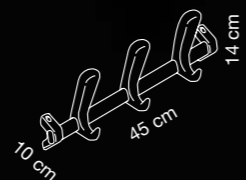

1523-N
1523-B
1523-T

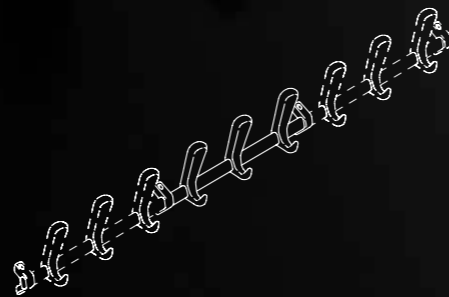

I→Portabiti da parete realizzato in tecnopolimero, grazie alla sua componibilità si possono ottenere configurazioni adatte sia a piccoli che grandi ambienti. GB→Wall-mounted coat-hooks in high-tech polymer, its modularity allows sizes suitable for both small and large rooms. F→Portemanteau mural en techno-polymère modulable qui permet des configurations indiquées pour pièces grandes ou petites. D→Wand-Kleiderhaken aus Technopolymer. Dank der Zusammenstellbarkeit kann man Konfigurationen enthalten, die sowohl für kleine als auch große Räume geeignet sind. E→Perchero de pared realizado en tecnopolimero, gracias a su componibilidad, se pueden obtener configuraciones aptas tanto para pequeños como grandes ambientes.



1519-BO
1519-N
30 x 6 x H 12,5 cm



1562
Nero - Black - Noir - Schwarz - Negro
1562-T
Blu trasparente - Transparent blue - Bleu transparent - Blau transparent - Azul transparente
1562-TT
Trasparente - Transparent - Transparent - Transparent - Transparente
35 x 7 x H 17 cm

1563
1563-T
1563-TT
51,5 x 7 x H 17 cm

1564
1564-T
1564-TT
68 x 7 x H 17 cm

I→Hook è un appendiabiti da parete modulare che consente di ottenere configurazioni adatte sia a piccoli ambienti che a spazi più ampi. Il tubo di sostegno è in acciaio cromato a sezione ellittica, i ganci e gli elementi di fissaggio a muro sono realizzati in policarbonato nero, trasparente o blu trasparente. Per una migliore facilità d'uso i ganci possono essere fissati, oppure scorrere liberamente lungo la barra. **GB**→Hook is a modular wall-mounted coat rail ideal for both small and larger spaces. Chrome-plated tubular steel support and elliptic-shaped cross-section; the hooks and the wall attachments are made of black, transparent or transparent blue polycarbonate. The hooks can be fixed, or allowed to run freely along the bar. **F**→Hook est un porte-manteau mural modulaire qui permet d'obtenir des configurations qui conviennent aussi bien à petits espaces qu'à espaces plus grands. Le tube de soutien est en acier chromé à section elliptique; les crochets et les éléments de fixation au mur sont en polycarbonate noir, transparent ou bleu transparent. Les crochets peuvent être fixés ou glisser librement le long de la barre pour plus de confort. **D**→Hook ist eine kombinierbare Wandgarderobe für ideale Kombinationen sowohl auf kleinem Raum als auch in größeren Räumen. Stützrohr aus verchromtem Stahl mit elliptischer Schnittlinie; die Haken und die Elemente, die an der Wand befestigt werden, sind aus schwarzem, transparentem oder blauem transparentem Polykarbonat. Für eine leichtere Handhabung kann man die Haken an der Stange befestigen oder aber auch frei entlang der Stange laufen lassen. **E**→Hook es un perchero de pared modular que permite obtener configuraciones adecuadas a grandes y pequeños espacios. Tubo de acero cromado de sección elíptica, ganchos y elementos de sujeción a la pared de policarbonato negro, transparente o azul transparente. Para facilitar el uso, los ganchos pueden quedar fijos o deslizarse libremente a lo largo de la barra.



I→Originale oggetto con la doppia funzione di porta-casco e portabiti, realizzato in acciaio verniciato con polveri epossidiche finitura grigio argento. Ricoperto frontalmente in espanso rigato per proteggere i caschi. **GB**→An original object used as helmet and clothes stand, carried out in powder-coated steel, silver grey finish. The front is covered with ribbed foam to protect the helmets. **F**→Un objet original qui sert comme porte-casque et portemanteau, réalisé en acier peint en époxy gris argenté. Le devant est recouvert d'expansé rayé pour protéger les casques. **D**→Originales Objekt mit doppelter Funktion als Helm- und Kleiderständer, hergestellt aus mit Epoxidpulver beschichtetem Stahl, Finish silbergrau. Vorderseite überzogen aus gerilltem Schaumstoff, zum Schutz der Helme. **E**→Original objeto con la doble función portacasco y perchero, de acero recubierto con polvo epoxi acabado gris plata. Recubierto por la parte delantera con material de espuma estriado para proteger los cascos.



1556-GA
10 x 5 x H 41 cm



I→Stander portabiti realizzato con struttura in acciaio verniciato con polveri epossidiche assemblata con giunti brevettati. La barra portabiti è in acciaio cromato. Le basi in alluminio lucido sono disponibili con piedini regolabili in acciaio zincato e tecnopolimero o su ruote in tecnopolimero. GB→Free-standing coat-rail with structure in epoxy painted steel assembled through patented joints. The bar is in chrome-plated steel. Bases in polished aluminium available with adjustable feet in zinc-coated steel and high-tech polymer or on casters in high-tech polymer. F→Portemanteaux réalisé avec structure en acier peint époxy assemblée à l'aide de joints brevetés. La barre portemanteaux est en acier. Les bases en aluminium poli sont disponibles avec pieds réglables en acier galvanisé et techno-polymère ou roulettes en techno-polymère. D→Kleiderständer mit einer Struktur aus mit Epoxidpulver beschichtetem Stahl, mit patentierten Verbindungsstücken montiert. Die Kleiderhaken-Stange besteht aus verchromtem Stahl. Die Basen aus glänzendem Aluminium sind mit verstellbaren Füßen aus verzinkten Stahl und Technopolymer oder auf Rädern aus Technopolymer erhältlich. E→Barra perchero realizada con estructura de acero recubierto con polvo epoxi ensamblada con juntas patentadas. La barra perchero es de acero cromado. Las bases de aluminio brillo existen con apoyos regulables de acero zincado y tecnopolímero o sobre ruedas de tecnopolímero.



Hook

I→Appendiabiti mobile su ruote con cappelliera, realizzato in tubolare d'acciaio verniciato con polveri epossidiche colore nero. Dotato di dodici ganci a due posizioni in policarbonato nero, montati su tubi in acciaio cromato a sezione ellittica. Le basi sono in tecnopolimero nero. Ruote in tecnopolimero nero. GB→Movable coat rail with hat rack and coat rail on castors carried out in epoxy painted tubular steel in black. Supplied with twelve hooks in black polycarbonate, mounted on chrome-plated steel tubes with elliptic section. Bases in black high-tech polymer. Castors in black high-tech polymer. F→Portemanteau sur roulettes avec porte-chapeaux réalisé en tubulaire d'acier peint en époxy, noir. Doté de douze crochets à deux positions en polycarbonate noir, montés sur des tubes en acier chromé à section elliptique. Les bases sont en techno-polymère noir. Roulettes en techno-polymère noir. D→Rollgarderobe mit Hutablage aus mit Epoxypulvern beschichtetem Stahl. Ausführung schwarz. Ausgerüstet mit zwölf Doppelhaken aus schwarzen Polykarbonat. Haken auf verchromtem Ovalrohr montiert. Füße aus schwarzem Technopolymer. Räder aus schwarzem Technopolymer. E→Perchero móvil de ruedas con soporte para sombreros, realizado en tubular de acero pintado con polvos epoxídicos en negro. Está equipado con doce ganchos de dos posiciones en policarbonato negro, armados sobre tubo de acero cromado de sección elíptica. Las bases son en tecnopolímero negro. Ruedas en tecnopolímero negro.

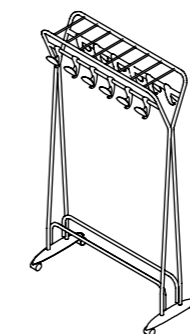

Stander

I→Appendiabiti mobile su ruote e cappelliera realizzati in acciaio cromato e acciaio verniciato con polveri epossidiche. Le ruote sono in tecnopolimero. GB→Mobile coat rail and hat rack in chrome-plated and epoxy-painted steel. The castors are in high-tech polymer. F→Portemanteau sur roulettes et porte-chapeaux réalisés en acier chromé et acier peint en époxy. Les roulettes sont en techno-polymère. D→Mobiler Kleiderständer und Hutablage aus mit Epoxypulvern beschichtetem Stahl und verchromtem Stahl. Die Rollen sind aus Technopolymer. E→Perchero móvil y porta sombreros realizados en acero cromado y acero pintado con polvos epoxídicos. Las ruedas son en tecnopolímero.

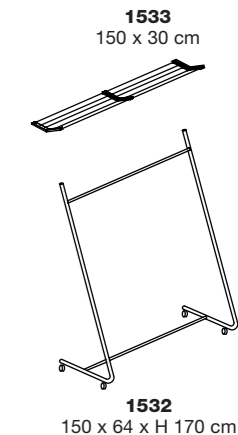



I→Grucce portabiti in tecnopolimero caratterizzata dalla forma inclinata a 45° pensata per ridurre lo spazio in profondità e per facilitare l'esposizione dei capi appesi. L'inclinazione a 45° rispetto alla barra d'appendimento è ideale per "mostrare" capi di abbigliamento in negozi e show-room e per rendere più veloce l'individuazione degli stessi nei guardaroba in spazi collettivi. **GB**→High-tech polymer clothes hanger marked by the 45°-inclined shape, designed to reduce the depth and make the display of the hung garments easier. The 45° inclination to the bar is perfect for "showing" the items of clothing in shops and showrooms and to distinguish one's garment quicker in the cloakrooms of communal public spaces. **F**→Cintre en technopolymère caractérisé par la forme inclinée à 45° qui réduit l'espace en profondeur et facilite l'exposition des pièces d'habillement accrochées. L'inclinaison à 45° par rapport à la barre d'accrochage est parfaite pour "montrer" les pièces d'habillement dans les magasins et les showrooms et pour les repérer plus vite dans les vestiaires des espaces communs. **D**→Kleiderbügel aus Technopolymere mit charakteristischer, um 45° geneigter Form, gedacht, um Platz in der Tiefe zu sparen und die Ausstellung der aufgehängten Kleidungsstücke zu erleichtern. Die 45° Neigung zur Kleiderstange ist ideal, um die Kleidungsstücke in Geschäften und Show-rooms zu "zeigen" und sie leichter in Gemeinschafts-Garderoben wiederzufinden. **E**→Percha portatrajes de tecnopolimero que se caracteriza por su forma inclinada 45°. Está ideada para reducir el espacio en profundidad y facilitar la exposición de las prendas expuestas. La inclinación de 45° respecto a la barra donde se cuelga es ideal para "mostrar" prendas de vestir en tiendas y show-rooms y también para facilitar la localización de las mismas en los guardarropas en espacios colectivos.



I→Innovativo sistema brevettato di marche e contromarche per spazi guardaroba, realizzate in elastomero traslucido flessibile. La "marca" da elemento bidimensionale diventa tridimensionale, abbraccia il collo dell'appendiabiti e rende leggibile la numerazione su tre lati. La morbida "contromarca" è comoda da tenere nelle tasche. **GB**→An innovative, patented system of coat checks for cloakrooms carried out in flexible, translucent elastomer. The "token" changes from a bidimensional element into a three-dimensional one, it embraces the neck of the clothes-hanger and the numbering can be read on three sides. The soft "token" is handy to keep in one's pockets. **F**→Un système innovateur breveté de marques et contremarques pour vestiaire, réalisés en élastomère translucide flexible. Le "jeton" de bidimensionnel devient tridimensionnel, il embrasse le cou du cintre et rend lisible la numérotation sur les trois côtés. La contremarque souple est pratique pour la garder dans ses poches. **D**→Ein innovatives, patentiertes System von Marken und Gegenmarken für Garderoben, hergestellt aus durchleuchtendem, flexiblem Elastomer. Die Marke wird von einem zweidimensionalen zu einem dreidimensionalen Element, umschlingt den Hals des Kleiderbügel und macht die Nummerierung auf drei Seiten leserlich. Die weiche "Gegenmarke" kann bequem in den Hosentaschen aufbewahrt werden. **E**→Innovador sistema patentado de fichas para guardarropas, realizados con elastómero translucido flexible. La "ficha prenda", elemento de dos dimensiones pasa a ser tridimensional, envuelve el cuello de la percha y se puede leer la numeración en sus tres lados. La suave "ficha cliente" se puede llevar cómodamente en los bolsillos.



I→Grucce appendiabiti in polipropilene. **GB**→Coat hanger in polypropylene. **F**→Cintre pour vêtements en polypropylène. **D**→Kleiderbügel aus Polypropylen. **E**→Percha para ropa en polipropileno.

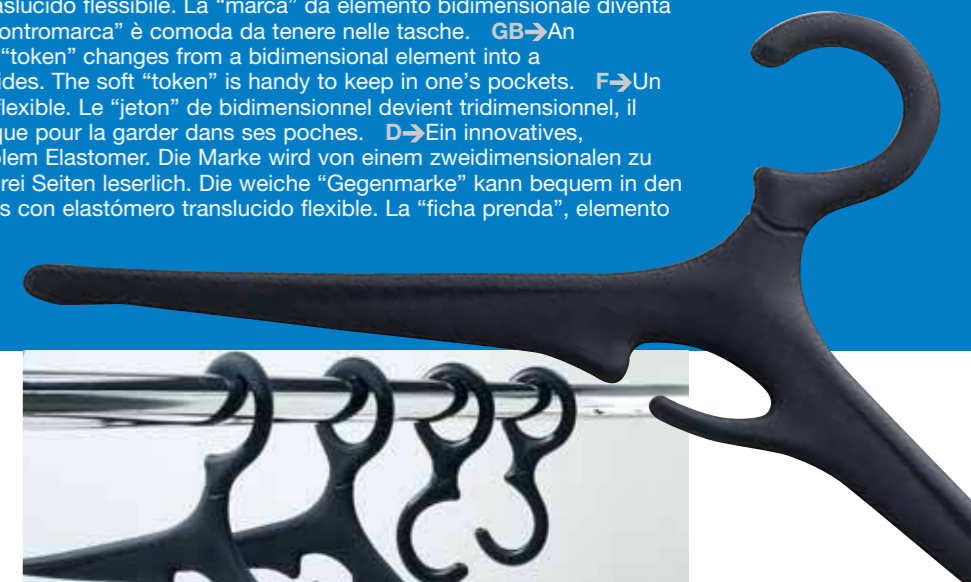
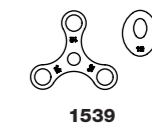
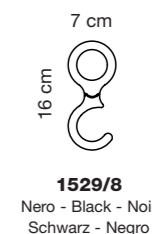
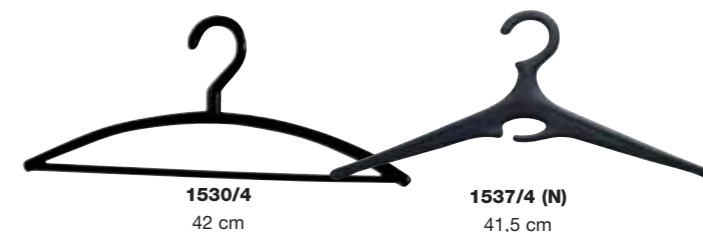
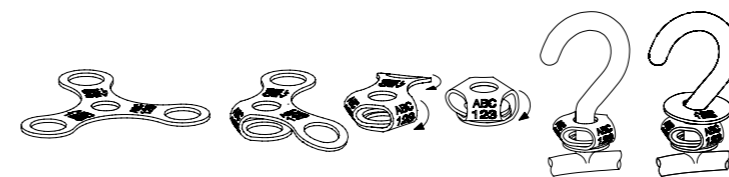

I→Ambrogio e Ambrogino sono sistemi componibili di portabiti da parete, caratterizzati dai particolari elementi di fissaggio a parete in alluminio lucido; i tubi di sostegno sono in acciaio cromato. Le grucce portabiti Ometto sono disponibili in due versioni: a gancio aperto e ad anello chiuso, inasportabile. **GB**→Ambrogio and Ambrogino are modular systems of wall-mounted coat rails marked by a special wall fastening in polished aluminium; the supporting tubes are in chrome-plated steel. The dress-hangers Ometto are available in two styles: open hook and ring, unremovable. **F**→Ambrogio et Ambrogino sont systèmes modulaires de portemanteaux muraux caractérisés par des éléments de fixation murale en aluminium poli; les tubes de support sont en acier chromé. Les cintres portemanteau Ometto sont disponibles en deux modèles: crochet ouvert et anneau, inamovible. **D**→Ambrogio und Ambrogino sind ein Kombiniersystem von Wandkleiderablagen, das durch besondere Wandfixierelemente aus glänzendem Aluminium gekennzeichnet ist; die Stützrohre sind aus verchromtem Stahl. Die Ometto Kleiderbügel sind in zwei Versionen erhältlich: mit offenem Haken oder mit geschlossenem, nicht entfernbarem Ring. **E**→Ambrogio y Ambrogino son sistemas componibles de perchas de pared, caracterizados por particulares elementos de clavado a la pared en aluminio brillante; los caños de soporte son en acero cromado. Hay dos tipos de perchas Ometto: con garfio abierto y con anillo cerrado, no quitable.

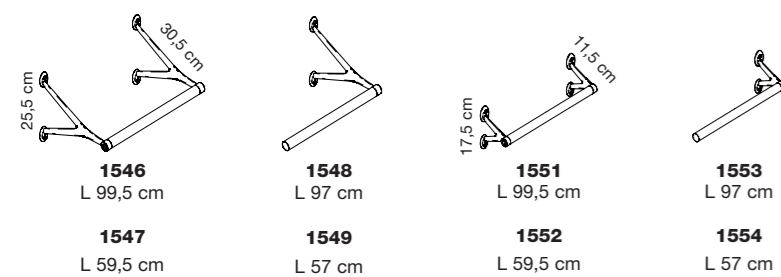

I→Portaombrelli a rastrelliera realizzato in acciaio verniciato con polveri epossidiche, le vaschette raccogli acqua possono essere posizionate a due altezze per contenere sia ombrelli normali che ombrelli pieghevoli. Le due ruote in tecnopolimero facilitano le operazioni di trasporto. GB→Umbrella-rack in epoxy-painted steel, the drip trays can be fixed at two heights for both ordinary and folding umbrellas. The two castors in high-tech polymer make the moving easier. F→Porte-parapluies à râtelier en acier peint époxy, les réceptacles peuvent être positionnés à deux hauteurs pour contenir les parapluies normaux comme pliables. Les deux roulettes en technopolymère facilitent le déplacement. D→Schirmständer-Gestell aus mit Epoxidpulver beschichtetem Stahl, die Abtropfwannen können auf zwei Höhen verstellt werden, für sowohl normale Schirme als auch für Klappschirme. Die zwei Räder aus Technopolymere erleichtern die Transportarbeiten. E→Paragüero con soportes de acero recubierto con polvo epoxi, los recogeaguas pueden colocarse en dos alturas diferentes para contener tanto los paraguas clásicos como los plegables. Las dos ruedas de tecnopolímero facilitan las operaciones de transporte.



510-GA
69 x 21,5 x H 55 cm

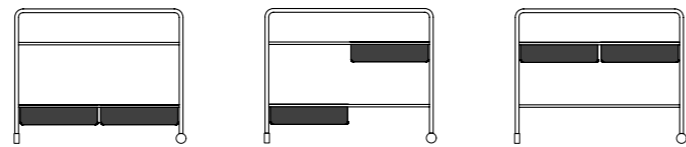

5831-GA
ø 60 x H 50 cm

I→Tavolini con piano in laminato stratificato HPL e struttura in acciaio verniciato con polveri epossidiche con predisposizione per l'eventuale fissaggio a terra. GB→Tables with top in HPL stratified laminate, structure in powder-coated steel. It can also be fixed to the floor. F→Tables en laminé stratifié HPL, structure en acier peint en époxy, prévue pour la fixation au sol. D→Tischchen, Fläche aus Schichtlaminat HPL, Struktur aus mit Epoxydpulver beschichtetem Stahl mit Vorrichtung zur Befestigung am Boden. E→Mesitas, superficie de laminado estratificado HPL, estructura de acero recubierto con polvo epoxi preparada para fijarse al suelo.



5830-GA
ø 60 x H 102 cm



Break area



372-I
ø 34 x H 60 cm



379
(6 pezzi per ogni simbolo;
6 pieces per each symbol)



I→Cestini ideati per la raccolta differenziata, realizzati interamente in acciaio inossidabile o in acciaio verniciato con polveri epossidiche, dotati di anello reggisacchetto asportabile. La foratura perimetrale permette, mediante apposito giunto in tecnopolimero, l'aggregazione di più cestini, con svariate possibilità di configurazione. **GB**→Waste paper baskets for the separate collection of waste entirely in stainless steel or in epoxy painted steel and supplied with a removable trash bag holder. The outer holes allow the use of more baskets through a special joint in high-tech polymer, in endless shapes. **F**→Corbeilles pour le ramassage sélectif des ordures, entièrement réalisées en acier inoxydable ou en acier peint en époxy, équipées d'un anneau porte-sac démontable. Le perçage périmétral permet, au moyen d'un joint spécial en technopolymère, l'assemblage de plusieurs corbeilles à former des configurations illimitées. **D**→Körbe für die Mülltrennung, hergestellt aus rostfreiem Stahl oder aus mit Epoxypulver beschichtetem Stahl, ausgestattet mit abnehmbarem Sackhalterungsring. Die Lochung entlang des gesamten Umfangs ermöglicht den Zusammenbau von mehreren Körben mit unbeschränkten Gestaltungsmöglichkeiten durch ein spezielles Verbindungsstück aus Technopolymer. **E**→Papeleras ideados para la recogida selectiva de desechos, realizados completamente de acero inoxidable o pintado con polvos epoxi, dotados de un anillo de sujeción de la bolsa extraíble. El perforado del perímetro permite, mediante la correspondiente junta de tecnopolímero, añadir más cubos, con ilimitadas posibilidades de configuración.

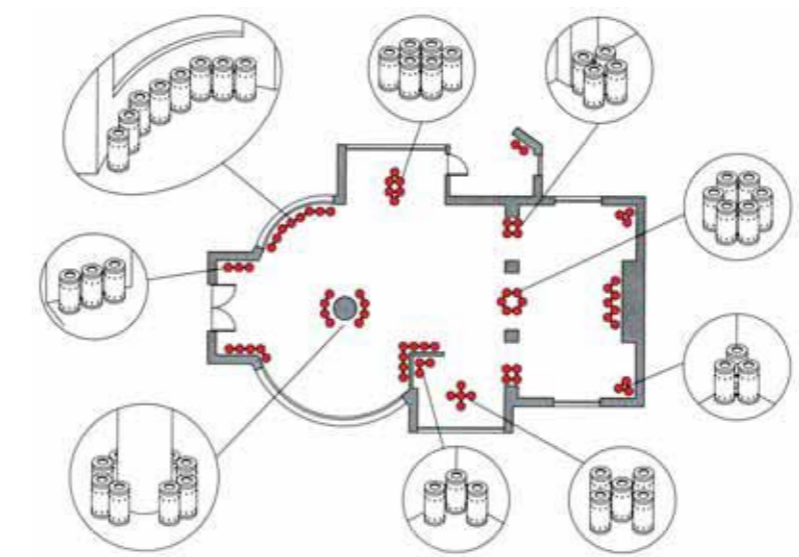

372-GA
ø 34 x H 60 cm

375-GA
ø 25 x H 60 cm



380-GM
I→Coppia giunti.
GB→Pair of joints.
F→Paire de joints.
D→Paar Verbindungssatz.
E→Par de juntas.

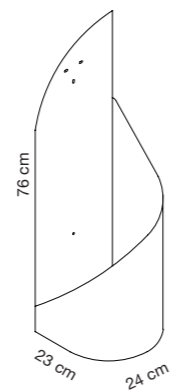

523-GA

I→Testato TUV
 GB→TUV tested
 F→Testé TUV
 D→TUV getestet
 E→Testado TUV

Grisù

I→Innovativo supporto porta-estintore brevettato, realizzato in acciaio zincato e verniciato con polveri epossidiche. **Testato TUV.** GB→Innovative, patented support for fire-extinguisher, carried out in zinc-coated and epoxy painted steel. **TUV tested.** F→Support innovateur porte-extincteur breveté, réalisé en acier galvanisé et peint époxy. **Testé TUV.** D→Innovative patentierte Feuerlöscherhalterung, hergestellt aus verzinktem Stahl und lackiert mit Epoxidpulver. **TUV getestet.** E→Innovador soporte porta-extintor patentado, realizado en acero zincado y recubierto con polvo epoxi. **Testado TUV.**



Piazza

I→Posacenere da parete utilizzabile anche per esterni, realizzato in acciaio inossidabile con vaschetta interna raccogli cenere estraibile, dotato di serratura di sicurezza. GB→Wall-mounted stainless steel ashtray for indoor and outdoor use, with internal extractable ash box, with safety lock. F→Cendrier mural utilisable aussi à l'extérieur, réalisé en acier inoxydable avec bac récepteur interne extractible pour les cendres et équipé d'une serrure de sécurité. D→Wand-Aschenbecher, kann auch im Freien verwendet werden, hergestellt aus rostfreiem Stahl mit herausnehmbarem Aschenbehälter, versehen mit Sicherheitsverschluss. E→Cenicero de pared utilizable también para exterior, realizado en acero inoxidable con recipiente interior de recogida de cenizas extraíble, dotado de cerradura de seguridad.

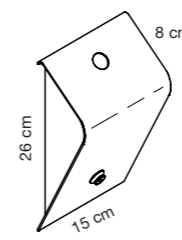

435-I

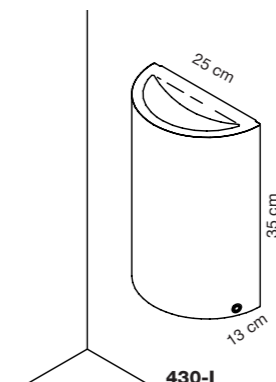

Smile

I→Cestino gettacarte da parete utilizzabile anche per esterni, realizzato in acciaio inossidabile con fondo forato per fare defluire l'acqua piovana, dotato di serratura di sicurezza. GB→Wall waste-paper basket also for outdoor use, carried out in stainless steel with perforated bottom for the outflow of rainwater, equipped with safety lock. F→Corbeille à papier murale utilisable aussi à l'extérieur, réalisée en acier inox, avec fond perforé pour l'écoulement de l'eau de pluie, pourvue de serrure de sûreté. D→Papierkorb für Wandmontage aus Inox, auch für Aussenanwendung geeignet, mit gelochtem Boden, damit das Regenwasser durchfließen kann, mit Sicherheitsschloss ausgestattet. E→Papelera a pared para exterior, realizada en acero inoxidable con fondo perforado para evacuar el agua de lluvia. Equipado con cerradura de seguridad.



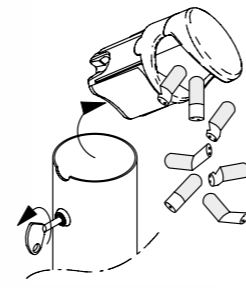

I→Serie brevettata di posacenere per esterni realizzati con fusto in alluminio verniciato con polveri epossidiche. Il posacenere, realizzato in fusione di alluminio verniciato con polveri epossidiche, può essere facilmente estratto per le operazioni di pulizia e svuotamento della cenere ed è dotato di un sistema di bloccaggio con serratura. Disponibile con base autoportante o con base per il fissaggio a terra, entrambe realizzate in acciaio zincato e verniciato con polveri epossidiche. L'attacco a muro della versione a parete è realizzato in acciaio zincato verniciato con polveri epossidiche. **GB**→A patented line of outdoor ashtrays featuring a powder-coated aluminium shaft. The ashtray, in powder-coated aluminium cast, may be easily pulled out for the cleaning and emptying of ash and is supplied with a locking system. Available with free-standing or floor-fixing base, both carried out in epoxy painted, zinc-plated steel. In the wall-mounted version the fastening to the wall is also in powder-coated, zinc-plated steel. **F**→Gamme breveté de cendriers pour l'extérieur réalisés avec fût en aluminium peint époxy. Le cendrier, en fusion d'aluminium peint époxy, est extrait facilement pour le nettoyage et le vidage de la cendre et il est équipé d'un système de blocage avec serrure. Disponible avec base autoportante ou base pour la fixation au sol, les deux réalisés en acier zingué et peints époxy. L'accrochage au mur du modèle mural est en acier zingué peint époxy. **D**→Patentierte Serie von Aschenbechern für draußen, Ständer aus mit Epoxidpulver beschichtetem Aluminium, kann leicht für Reinigungsarbeiten und das Entleeren der Asche herausgezogen werden und ist mit einem Sperrsystem mit Schloss ausgestattet. Verfügbar mit selbsttragender Basis oder mit Basis zur Befestigung am Boden, beide aus verzinktem und mit Epoxidpulver beschichtetem Stahl. Die Befestigung an der Wand für die Wandversion ist aus verzinktem und mit Epoxidpulver beschichtetem Stahl. **E**→Serie patentada de ceniceros para exterior con cuerpo en aluminio recubierto con polvo epoxi. El cenicero, de fusión de aluminio recubierto con polvo epoxi, puede sacarse fácilmente para las operaciones de limpieza y vaciado de la ceniza y está dotado de un sistema de bloqueo con cerradura. Disponible con base auto-portante o con base para la sujeción al suelo, ambas de acero zincado y recubierto con polvo epoxi. La sujeción a la pared de esta versión de pared es de acero zincado recubierto con polvo epoxi.

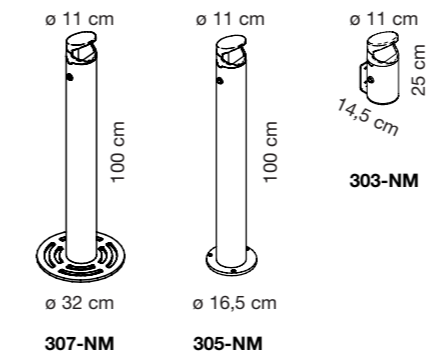



201-I

I→Giunto di connessione rapida realizzato in alluminio e velcro, ideato per creare composizioni di più contenitori, facilmente separabili per operazioni di pulizia e manutenzione. GB→Quick connection joint carried out in aluminium and velcro, designed to allow more containers in one arrangement, easy to separate for the cleaning and maintenance. F→Joint de connexion rapide réalisé en aluminium et velcro, idéal pour créer des compositions avec plusieurs récipients, facilement séparables pour le nettoyage et l'entretien. D→Schnellverbindung, hergestellt aus Aluminium und Velcro, gedacht, um Kompositionen mit mehreren Behältern zu erzeugen, die leicht zur Reinigung und Wartung getrennt werden können. E→Junta de conexión rápida de aluminio y velcro concebida para crear composiciones de varios contenedores, que pueden separarse fácilmente para operaciones de limpieza y mantenimiento.



I→Innovativo ed elegante sistema di accessori contenitori, formato da portaombrelli per ombrelli a bastone o pieghevoli, posacenere, gettacarte e fioriere, realizzato interamente in acciaio inox caratterizzato dalla lavorazione a nastro dei fusti. I contenitori disponibili in varie altezze ed aggregabili tra loro mediante giunti in alluminio e velcro, hanno le estremità arrotondate, antiurto e anti-infortunio, inoltre i bordi perimetrali sporgenti realizzati con doppio spessore conferiscono rigidità e resistenza ai prodotti. La funzionalità e l'utilizzo specifico di ogni singolo fusto viene attribuita dall'aggregazione dei differenti accessori disponibili nel sistema. GB→Innovative and elegant system of containers, formed by umbrella stand for ordinary or folding umbrellas, ashtray, waste paper basket and flower box, entirely in stainless steel and marked by the ribbon-working of shafts. The containers available in different heights can be linked through aluminium and Velcro joints and have rounded, shock-proof and accident-proof edges; in addition, the broad, double-thickness edges lend rigidity and resistance to the product. The practicality and specific use of each single shaft is enabled by the many accessories available with this system. F→Système innovateur et élégant d'accessoires-bacs formé de porte-parapluies, normaux et pliables, cendrier, corbeille à papier et jardinière, entièrement réalisés en acier inoxydable et caractérisés par le travail à ruban du fût. Les bacs disponibles en plusieurs hauteurs et assemblables à l'aide de joints en aluminium et velcro ont les extrémités arrondies, antichoc et à l'épreuve d'accidents, en outre les bords périmétriques en saillie à double épaisseur donnent de la rigidité et résistance aux produits. La fonctionnalité et l'emploi spécifique de chaque fût sont attribués par les différents accessoires disponibles dans le système. D→Innovatives und elegantes Zubehörbehältersystem für Schirme oder Klappschirme, Aschenbecher, Papierkorb und Blumentöpfe, hergestellt zur Gänze aus rostfreiem Stahl, charakterisiert sich durch die Bandverarbeitung der Gestelle. Die Behälter sind in einiger Größen erhältlich und können durch Aluminium und Velcro miteinander verbunden werden, sie haben abgerundete Enden zum Schutz vor Stößen und Verletzungen, außerdem sind die überragenden Ränder verdickt und verleihen den Produkten Festigkeit und Resistenz. Die Funktionstüchtigkeit und der besondere Gebrauch jedes einzelnen Gestells ergeben sich aus der Verbindung der verschiedenen im System verfügbaren Zubehörteile. E→Innovador y elegante sistema de accesorios contenedores, formado por paragueros tanto para paraguas clásicos como para los plegables y ceniceros, papeleras y macetas completamente de acero inoxidable, está caracterizado por la elaboración de cinta de los cuerpos. Los contenedores, disponibles en diferentes alturas y que pueden unirse entre sí mediante las juntas de aluminio y velcro, tienen las extremidades redondeadas, antichoque y antiaccidente. Además, haber realizado los bordes perimetrales que sobresalen con doble espesor, aporta rigidez y resistencia a los productos. La funcionalidad y el uso específico de cada contenedor vienen dados por la disposición de los diferentes accesorios disponibles en el sistema.

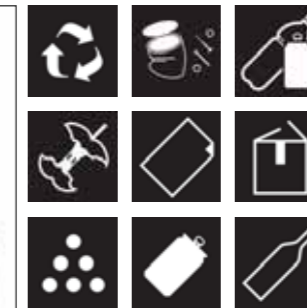

379
(6 pezzi per ogni simbolo;
6 pieces per each symbol)

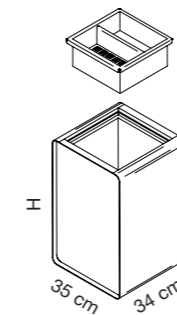

265-I
H 50 cm

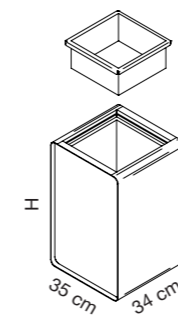

255-I
H 50 cm

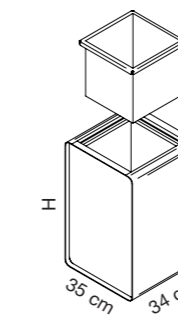

273-I
H 35
275-I
H 50 cm
277-I
H 70 cm

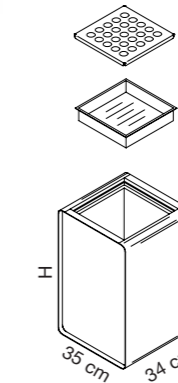

245-I
H 50 cm
247-I
H 70 cm

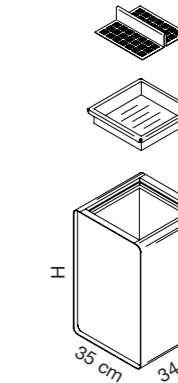

235-I
H 50 cm
237-I
H 70 cm

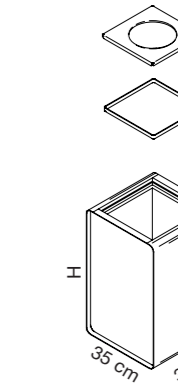

213-I
H 35
215-I
H 50 cm
217-I
H 70 cm

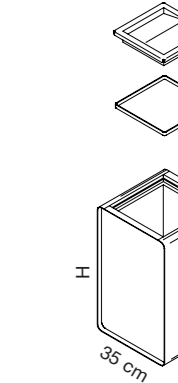

223-I
H 35
225-I
H 50 cm
227-I
H 70 cm



106-N (GM)
ø 12 x H 5,5 cm



106-N (N)
ø 12 x H 5,5 cm

I→Serie di posacenere in acciaio verniciato con polveri epossidiche e coperchio in alluminio anodizzato nero.
GB→Line of ashtrays in powder-coated steel and cover in black anodized aluminium.
F→Gamme de cendriers en acier peint en époxy et couvercle en aluminium anodisé noir.
D→Aschenbecherset aus mit Epoxypulvern lackiertem Stahl, mit Deckel aus schwarz anodisiertem Aluminium.
E→Serie de ceniceros en acero barnizado con polvos epoxídicos y tapa en aluminio anodizado negro.



472 A

I→Reggisacchetto
GB→Liner holder
F→Porte-sac
D→Müllsackbehälter
E→Sujeta bolsas



393-I A
ø 25 x H 60 cm

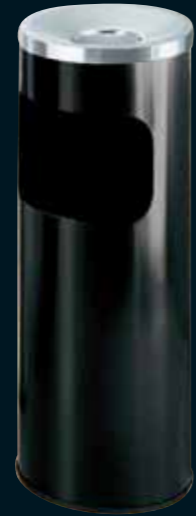

393 (N) A
ø 25 x H 60 cm



394-GA A
ø 25 x H 60 cm



393-SPNGA A
ø 25 x H 60 cm



393-SPN (N) A
ø 25 x H 60 cm



392-I A
ø 25 x H 60 cm



I→A= ANTINCENDIO Linea di posacenere e gettacarte realizzati in acciaio verniciato con polveri epossidiche o inossidabile e con base di protezione in tecnopolimero. Dotati di una particolare struttura interna a doppiofondo in acciaio che ne garantisce le proprietà ignifughe. Possono essere completati da reggisacchetto interno.
GB→A= FIRE-RESISTANT Line of ashtrays and wastepaper baskets in epoxy painted or stainless steel with guard base in high-tech polymer. They are provided with a special double bottom in steel ensuring its fireproofing. They can be equipped with an inner liner holder.
F→A= ANTI-FEU Gamme de cendriers et corbeilles à papier réalisés en acier peint en époxy ou inox avec base de protection en techno-polymère. Dotés d'un double fond spécial en acier qui en assure les propriétés ignifuges. On peut les compléter avec porte-sac interne.
D→A=FEUERFESTE Aschenbecher und Papierkörbe aus Stahl, Epoxypulvern beschichtet oder Inox. Boden aus Technopolymer. Die spezielle Ausführung aus Stahl mit Doppelboden macht diese Teile flammhemmend. Auf Wunsch auch mit Einsatz für Müllsack erhältlich.
E→A=ANTINCENDIO Línea de ceniceros y papeleras realizados en acero pintado con polvos epoxídicos o inoxidable y con base de protección en tecnopolimero. Tienen una estructura interna particular con fondo doble en acero que garantiza sus propiedades ignífugas. Pueden equiparse con aro interior para sostener la bolsa.



Nuova Fiera Milano - Rho (Italy)



Nuova Fiera Milano - Rho (Italy)

I→Cestini gettacarte e portaombrelli realizzati in acciaio verniciato con polveri epossidiche, rivestiti con espanso rigato nero o grigio argento, base in tecnopolimero e anello superiore in tecnopolimero o acciaio cromato. Posacenere/gettacarte realizzati in acciaio verniciato con polveri epossidiche, rivestito con espanso rigato grigio argento, base in tecnopolimero con doppio fondo in acciaio, coperchio posacenere in acciaio cromato con contenitore asportabile in alluminio. I posacenere/gettacarte possono essere dotati di reggisacchetto interno in acciaio verniciato con polveri epossidiche. **GB**→Waste paper baskets and umbrella stands, covered with black or silver grey ribbed plastic foam, base in high-tech polymer and upper ring in high-tech polymer or chrome-plated steel. Paper basket/ashtray carried out in epoxy painted steel, covered with silver grey ribbed plastic foam, base in high-tech polymer with double bottom in steel, ashtray lid in chrome-plated steel with removable container in aluminium. The paper basket/ashtray may come with a bag holder in epoxy painted steel. **F**→Corbeilles à papier et porte-parapluies réalisés en acier peint époxy, recouverts d'expansé rayé noir ou gris argenté, base en techno-polymère et anneau supérieur en techno-polymère ou acier chromé. Cendrier/corbeille à papier réalisés en acier peint époxy, recouvert d'expansé rayé gris argenté, base en techno-polymère à double fond en acier, couvercle cendrier en acier chromé avec réceptacle en aluminium. Les cendriers/corbeilles à papier peuvent être dotés de porte-sacs internes en acier peint époxy.

D→Papierkörbe und Schirmständer aus mit Epoxidpulver beschichtetem Stahl, verkleidet mit gerilltem schwarzem oder silbergrau Schaumstoff. Die Basis aus Technopolymer und einem oberen Ring, bestehend aus Technopolymer oder verchromtem Stahl. Aschenbecher/Papierkorb hergestellt aus mit Epoxidpulver beschichtetem Stahl, verkleidet mit gerilltem silbergrau Schaumstoff. Die Basis ist aus Technopolymer mit einem doppelten Boden aus Stahl hergestellt. Der Aschenbecherdeckel besteht aus verchromtem Stahl und verfügt über einen abnehmbaren Behälter aus Aluminium. Die Aschenbecher/Papierkörbe können mit einer innen angebrachten Sackhalterung aus mit Epoxidpulver beschichtetem Stahl ausgestattet werden. **E**→Papeleras y porta-paraguas realizados en acero recubierto con polvo epoxi, revestidos con material de espuma estriado negro o gris plata, base en tecnopolímero y aro superior de tecnopolímero o acero cromado. Cenicero/papelera realizados en acero recubierto con polvo epoxi, revestido con material de espuma estriado gris plata, base en tecnopolímero con doble fondo de acero, tapa del cenicero de acero cromado con recipiente extraíble de aluminio. Los ceniceros/papeleras pueden llevar una sujeción de bolsa interior de acero recubierto con polvo epoxi.



393-GA
ø 25 x H 60 cm



I→Reggisacchetto in polipropilene nero.
GB→Liner holder in black polypropylene.
F→Porte-sac en polypropylène noir.
D→Müllsackbehälter aus schwarzem Polypropylen.
E→Sujeta bolsas en polipropileno negro.

419 (N)
418 (N)



505-NG
ø 25 x H 50 cm



411-NG
ø 25 x H 32 cm



507-GA
ø 25 x H 50 cm



417-GA
ø 25 x H 32 cm

I→Linea direzionale di cestini gettacarte e portaombrelli realizzati in acciaio inox o in acciaio verniciato con polveri epossidiche rivestito con ecopelle. L'anello superiore è in acciaio cromato e la base in tecnopolimero antiurto. GB→Executive line of waste-paper baskets and umbrella stands, finished in stainless steel or in epoxy painted steel, covered with imitation leather. The top ring is in chrome-plated steel, and the base is made of shock-resistant high-tech polymer material. F→Gamme de corbeilles à papier et porte-parapluies pour bureau de direction réalisée en acier inox ou en acier peint en époxy, recouvert de éco-cuir. L'anneau supérieur est en acier chromé et la base est en techno-polymère anti-chocs. D→Exklusives Programm von Papierkörben und Schirmständern aus Edelstahl oder mit Epoxypulver beschichtetem Stahl, verkleidet mit Kunstleder. Der obere Ring ist aus verchromtem Stahl und die Basis aus stoßfestem Technopolymer. E→Línea de dirección de papeleras o paragüeros realizados en acero inoxidable o en acero pintado con polvos epoxí revestido con ecopiel. El anillo superior es en acero cromado y la base en tecnopolímero antichoque.



507
ø 25 x H 50 cm

417
ø 25 x H 32 cm

507-I
ø 25 x H 50 cm

417-I
ø 25 x H 32 cm



I→A= ANTINCENDIO Serie di cestini gettacarte e portaombrelli realizzati con particolare struttura in acciaio verniciato con polveri epossidiche che ne garantisce le proprietà ignifughe. GB→A= FIRE-RESISTANT Line of waste-paper baskets and umbrella stands featuring a special structure in epoxy painted steel ensuring its fireproofing. F→A= ANTI-FEU Gamme de corbeilles à papier et porte-parapluies dont la structure spéciale en acier peint en époxy en assure les propriétés ignifuges. D→A= FEUERFESTE Linie von Papierkörben und Schirmständern aus mit Epoxypulvern beschichtetem Stahl. Dank der speziellen Stahlausführung ist diese Serie flammhemmend. E→A= ANTINCENDIO Serie de papeleras y paragüeros realizados en estructura en acero pintado con polvos epoxídicos que garantizan sus propiedades ignífugas.



416 (N) A
416-GA A
ø 36 x H 50 cm

496-N A
496-GA A
ø 24 x H 50 cm

402-N A
402-GA A
ø 24 x H 35 cm



418 - 418-GR

I→Reggisacchetto in polipropilene. GB→Liner holder in polypropylene. F→Porte-sac en polypropylène. D→Müllsackbehälter aus Polypropylen. E→Sujeta bolsas en polipropileno.

419 - 419-T

I→Anello reggisacchetto per raccolta differenziata realizzato in polipropilene nero o traslucido. GB→Liner holder for the separate collection of waste in black or translucent polypropylene. F→Anneau porte-sac pour le ramassage séparé des déchets réalisé en polypropylène noir ou translucide. D→Mülltrennring und Halterung für Müllsack aus schwarzem oder lichtdurchlässigem Polypropylen. E→Aro para sostener la bolsa para la recogida diferenciada de residuos realizado en polipropileno negro o traslucido.



418-GR



418 (N)



419-T (TA)



419-T (TB)



419-T (TV)



419 (N)

I→Cestini gettacarte e portaombrelli realizzati in acciaio verniciato con polveri epossidiche. Anello superiore e base in tecnopolimero. Possono essere dotati di reggisacchetto semplice o per la raccolta differenziata. GB→Wastepaper baskets and umbrella stands in epoxy painted steel. Upper ring and base in high-tech polymer. They can be equipped with liner holder, plain or for separate collection of waste. F→Corbeilles à papier et porte-parapluies réalisés en acier peint en époxy. Anneau supérieur et base en techno-polymère. Ils peuvent être dotés de porte-sac simple ou pour le ramassage séparé. D→Papierkörbe und Schirmständer aus mit Epoxypulver beschichtetem Stahl. Oberer Ring und Boden aus Technopolymer. Als Ergänzung: Mülltrennring und Halterung für Müllsack. E→Papeleras y paragüeros realizados en acero pintado con polvos epoxídicos. Aro superior y base en tecnopolimero. Pueden equiparse con aro para sostener la bolsa, simple o para recogida diferenciada de residuos.



506-N
ø 25 x H 50 cm
411-N
ø 25 x H 32 cm



506-GA
ø 25 x H 50 cm
411-GA
ø 25 x H 32 cm



506-F
ø 25 x H 50 cm
412-F
ø 25 x H 32 cm



506-GAF
ø 25 x H 50 cm
412-GAF
ø 25 x H 32 cm



I→Cestino gettacarte impilabile realizzato in fibra di legno riciclata e polipropilene. Un cestino "ecologico" che permette un utilizzo intelligente del materiale riciclato, riducendo l'uso di materie prime, contribuendo alla salvaguardia dell'ambiente. **GB**→Stackable waste-paper basket in recycled wood fibre and polypropylene. An "eco-friendly" basket allowing a clever use of the recycled material, reducing the use of raw materials, thus helping to environmental protection. **F**→Corbeille à papier superposable réalisée en fibre de bois recyclée et polypropylène. Une corbeille "écologique" qui permet un emploi intelligent du matériel recyclé, réduisant l'usage de matières premières, contribuant ainsi à la sauvegarde du milieu. **D**→Papierkorb, stapelbar, aus Fasern aus recyceltem Holz und Polypropylen. Ein „umweltbewusster“ Papierkorb, der die intelligente Verwendung von recyceltem Material erlaubt, wodurch die Verwendung von Rohstoffen reduziert wird, was einen Beitrag zum Umweltschutz bedeutet. **E**→Papelera apilable de fibra de madera reciclada y polipropileno. Una papelera "ecológica" que permite un uso inteligente del material reciclado, reduciendo el uso de materias primas y contribuyendo a la protección del medio ambiente.



414-ECO
ø 28 x H 35 cm



414-TA ø 28 x H 35 cm
414-TV ø 28 x H 35 cm
414-TB ø 28 x H 35 cm
414-OP T ø 28 x H 35 cm
414-BO BO ø 28 x H 35 cm
414 N ø 28 x H 35 cm
414-GR GR ø 28 x H 35 cm
414-GM GM ø 28 x H 35 cm

I→Cestino gettacarte impilabile in polipropilene nero, grigio, bianco opaco o traslucido o in tecnopolimero verniciato grigio metallizzato, con bordo di irrigidimento arrotondato. **GB**→Stackable waste-paper basket made of black, grey, mat white or translucent polypropylene or in metal grey painted high-tech polymer with a rounded rim stiffener. **F**→Corbeille à papier empilable en polypropylène noir, gris, blanc mat ou translucide ou en techno- polymère peint en gris métallisé avec bord de finition arrondi. **D**→Stapelbarer Papierkorb in schwarzem, grauem, mattweiß oder lichtdurchlässigem Polypropylen oder weissalu beschichtetem Technopolymer mit versteiftem, abgerundetem Rand. **E**→Papelera apilable en polipropileno negro, gris, blanco mate o traslucido o en tecnopolimero barnizado gris metalizado con borde de refuerzo redondeado.



415 415-BO 415-GR 415-GM 415-T

I→Anello reggisacchetto per raccolta differenziata realizzato in polipropilene nero, grigio, bianco, traslucido o in tecnopolimero verniciato grigio metallizzato. **GB**→Liner holder for the separate collection of waste carried out in black, grey or translucent polypropylene or in metal grey painted high-tech polymer. **F**→Anneau porte-sac pour le ramassage séparé des déchets réalisé en polypropylène noir, gris ou translucide ou en techno-polymère peint gris métallisé. **D**→Mülltrennring und Halterung für Müllsack aus schwarzem, grauem, mattweiß oder lichtdurchlässigem Polypropylen oder weissalu beschichtetem Technopolymer. **E**→Aro para sostener la bolsa para la recogida diferenciada de residuos realizado en polipropileno negro, gris o traslucido o en tecnopolimero barnizado gris metalizado.



415 N
415-BO BO
415-GR GR
415-GM GM
415-T TB
415-T TA
415-T TV

I→Cestino gettacarte impilabile con texture rigata opaca, realizzato in policarbonato trasparente o rosso trasparente.
GB→Stackable waste paper basket with mat ribbed texture, carried out in transparent or transparent red polycarbonate.
F→Corbeille à papier superposable, finition rayée opaque, réalisée en polycarbonate transparent ou rouge transparent.
D→Papierkorb, stapelbar mit gerillter, matter Textur, hergestellt aus transparentem oder rot transparentem Polycarbonat.
E→Papelera apilable con textura estriada mate, de policarbonato transparente o rojo transparente.



413-T
 ø 28 x H 35 cm

413-TRO
 ø 28 x H 35 cm

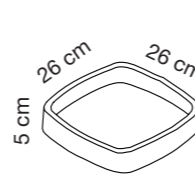

422-N 422-B
I→Reggisacchetto in tecnopolimero lucido.
GB→Trash bag holder in glossy high-tech polymer.
F→Porte-sacs en technopolymère brillant.
D→Sackhalterung aus glänzendem Technopolymer.
E→Sujetabolsa de tecnopolímero brillante.



421-B + 422-B

421-N + 422-N

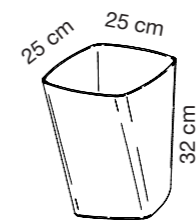

421-N 421-B
I→Cestino gettacarte realizzato in tecnopolimero lucido.
GB→Waste paper basket carried out in glossy high-tech polymer.
F→Corbeille à papier réalisée en technopolymère brillant.
D→Papierkorb aus glänzendem Technopolymer.
E→Papelera de tecnopolímero brillante.







1330-T (T)
1330-T (TRO)
1330-GM
1330-B
1330-N
 28,5 x 36,5 x H 7 cm



1336-T (T)
1336-T (TRO)
1336-GM
1336-B
1336-N
 29 x 16 x H 6,5 cm



1338-T (T)
1338-T (TRO)
1338-GM
1338-B
1338-N
 10 x 10,5 x H 10 cm



1331-T (T)
1331-T (TRO)
1331-GM
1331-B
1331-N



1463
 50 x 35 cm
1463-M
 60 x 40 cm

I→Streamline è composto da una cassetta portacorrispondenza, un portaoggetti ed un portapenne realizzati in policarbonato trasparente, rosso trasparente, nero e bianco lucido o verniciato grigio metallizzato. La linea è completata da un sottomano in espanso nero. **GB**→Streamline consists of a letter tray, an object holder and a pen holder carried out in polycarbonate, transparent, transparent red, black and glossy white or painted metal grey. The line includes also a desk-pad in black foam. **F**→Streamline est formé d'un bac à courrier, un porte-objet et un porte-plume réalisés en polycarbonate transparent, rouge transparent, noir et blanc brillant ou peint en gris métallisé. La gamme comporte aussi un sous-main en expansé noir. **D**→Streamline besteht aus eine Papierablage, eine Objektsablage und einem Schreibzeugbehälter aus transparentem Polykarbonat, rot transparent, schwarz und weiß poliert oder grau metall lackiert. Die Linie ist komplett mit einer Schreibunterlage aus schwarzem Schaumstoff. **E**→Streamline está formado por un cajón para la correspondencia, un portaobjetos y portabolígrafos de policarbonato transparente, rojo transparente, negro y blanco brillante o recubierto gris metalizado. La línea se completa con un vade de espuma de poliuretano negro.



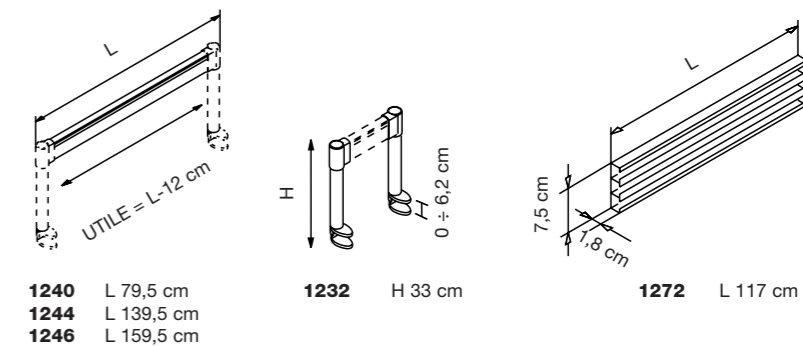
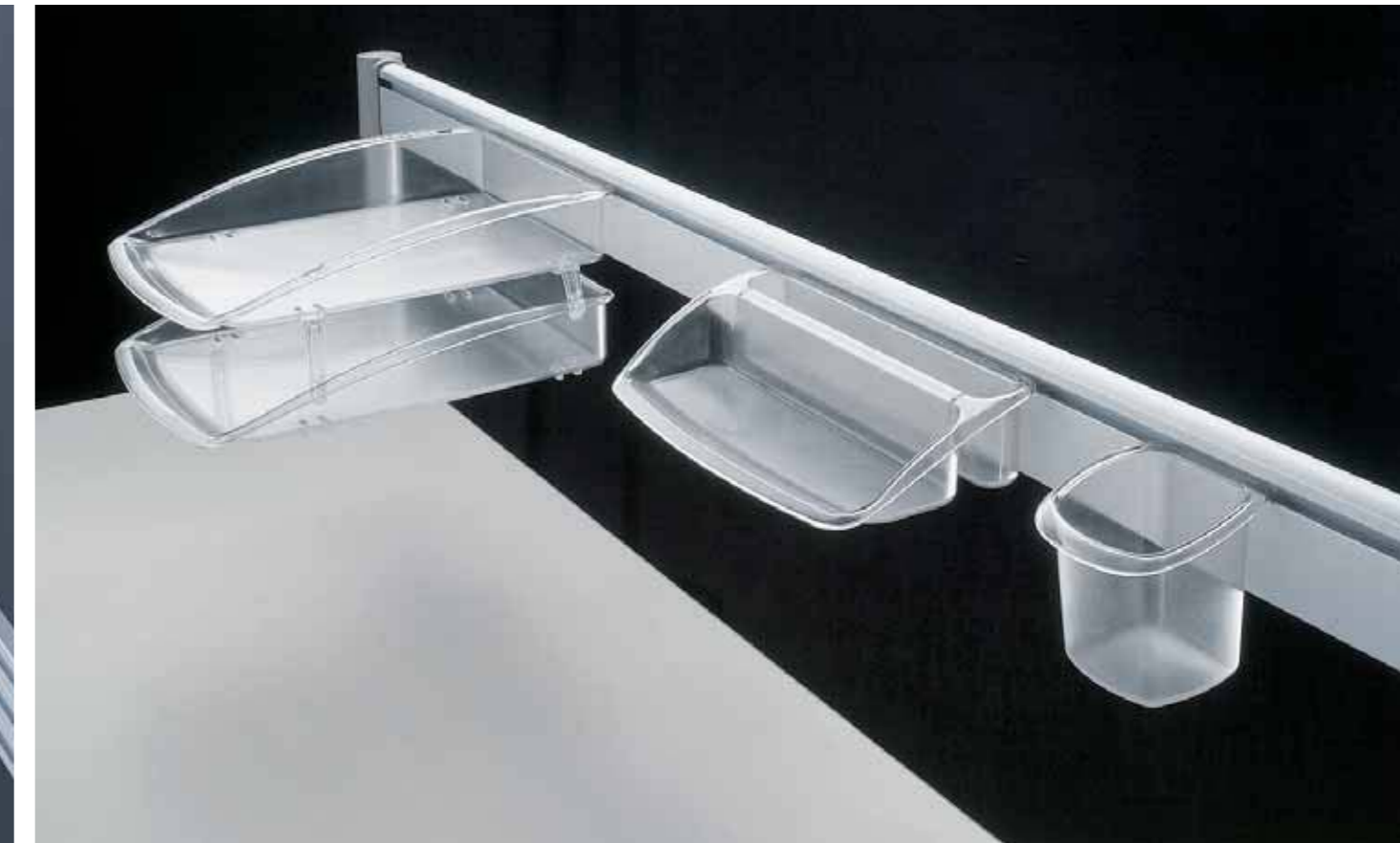

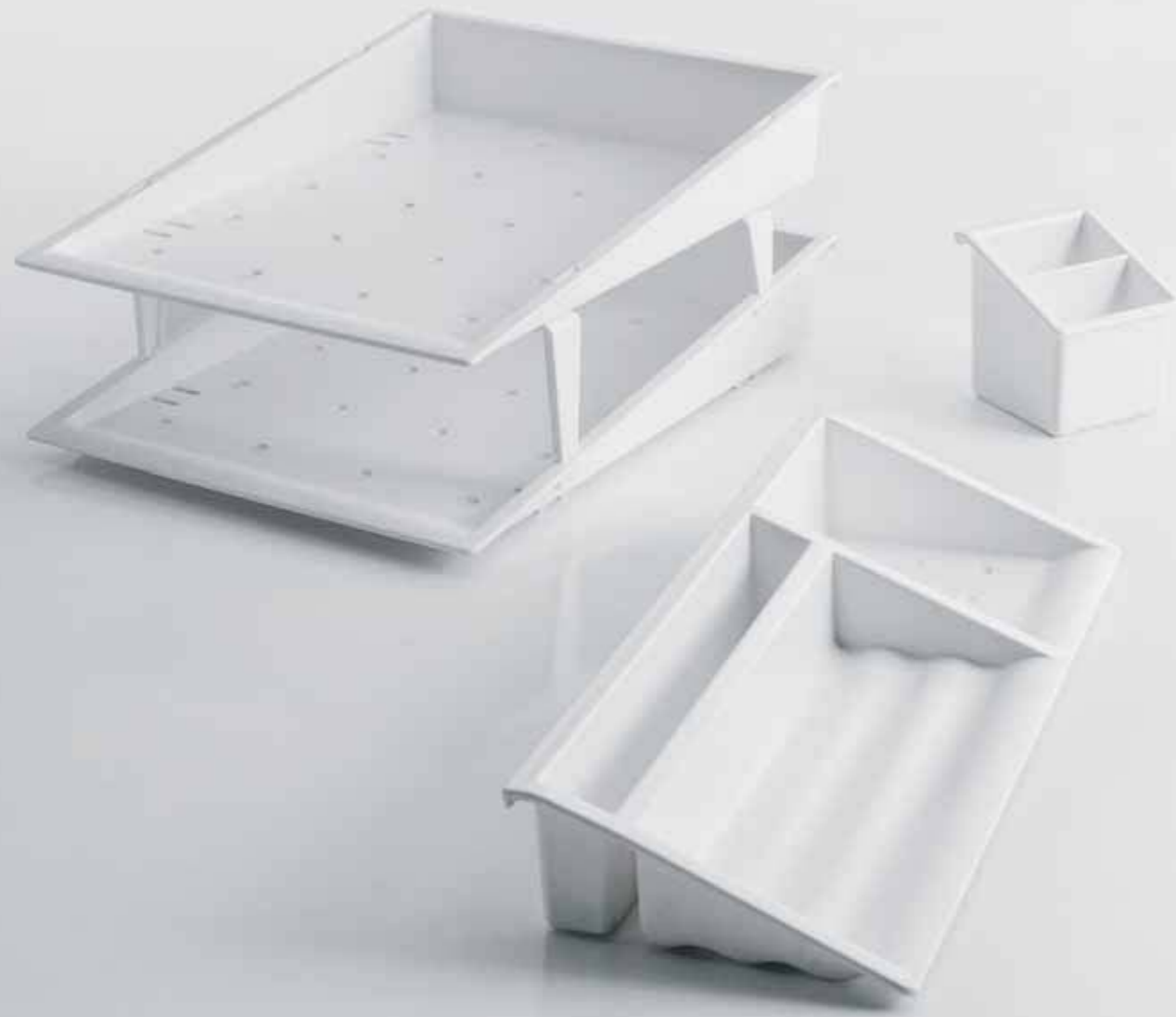

I→Desk Up è una linea di accessori per scrivania realizzati in tecnopolimero nero o bianco opaco o verniciato colore grigio metallizzato oppure in policarbonato trasparente o blu trasparente. Le cassette portacorrispondenza sono impilabili. **GB**→Desk Up is a line of desk accessories carried out in black or mat white or painted metal grey high-tech polymer, as also in transparent or transparent blue polycarbonate. The letter trays are stackable. **F**→Desk Up est une ligne d'accessoires de bureau réalisée en techno-polymère noir, blanc mat ou peint en gris métallisé et en polycarbonate transparent ou bleu transparent. Les bacs à courrier sont superposables. **D**→Desk Up ist ein kreatives Schreibtischerweiterungssystem aus schwarzem oder mattweiß Technopolymer oder alufarbenem beschichtetem sowie aus transparentem oder blau transparentem Polykarbonat. Die Briefkörbe sind stapelbar. **E**→Desk Up es una línea de accesorios para escritorio realizados en tecnopolimero negro o blanco mate o pintado color gris metalizado o en policarbonato transparente o azul transparente. Las cajas porta correspondencia pueden apilarse.

1463-M
60 x 40 cm
1463
50 x 35 cm

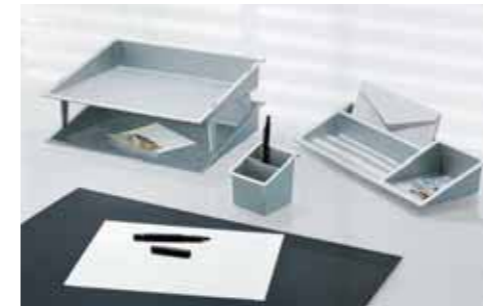

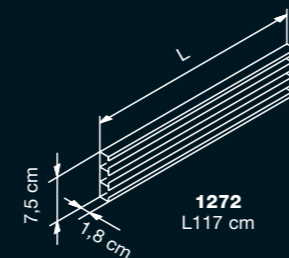
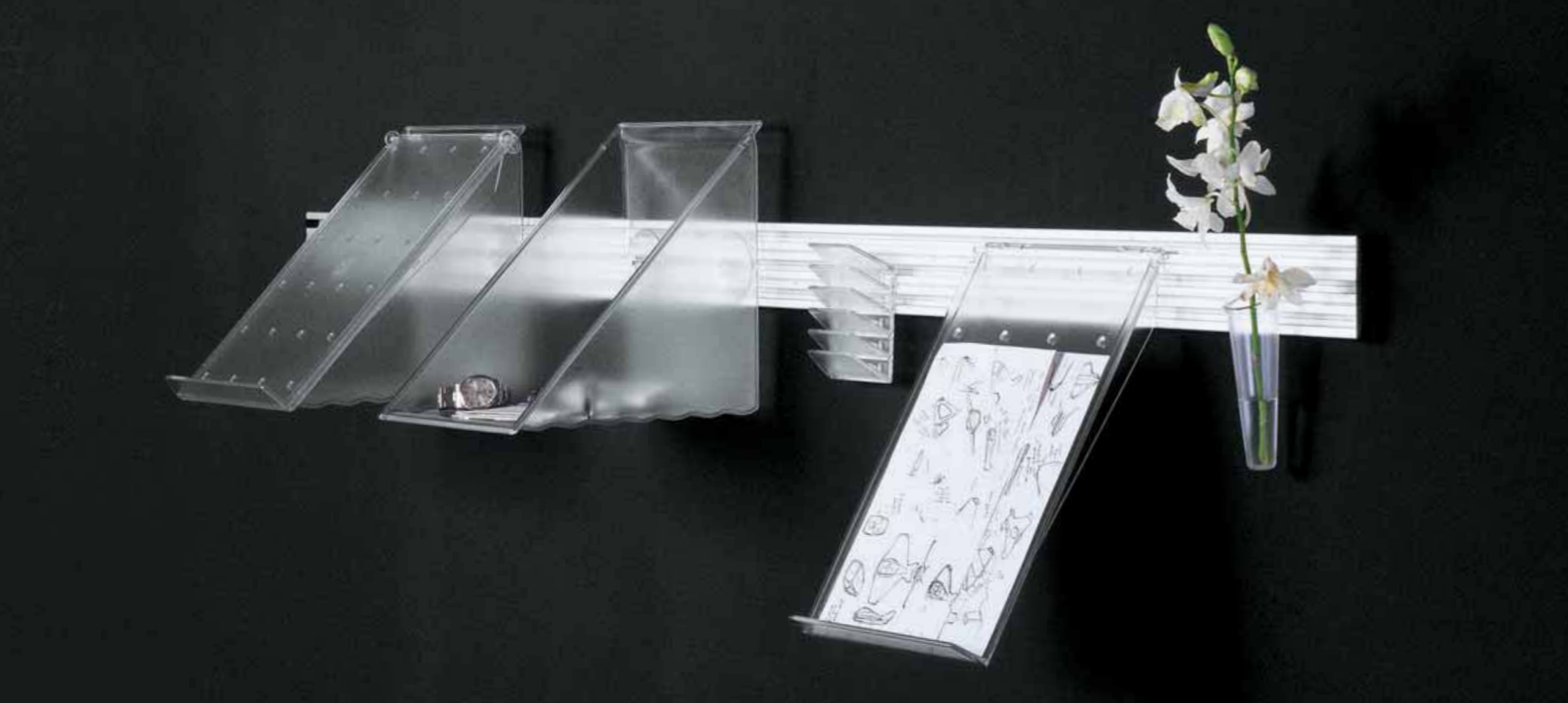

1200-BO	1209-BO	1201-BO	1206-BO	1208-BO		
		Bianco opaco - Mat white - Blanc mat - Mattweiß - Blanco mate				
1200	1209	1201	1206	1208		1205
		Nero - Black - Noir - Schwarz - Negro				
1200-GM	1209-GM	1201-GM	1206-GM	1208-GM		
		Grigio metallizzato - Metal grey - Gris métallisé - Alufarben - Gris metalizado				
1200-T	1209-T	1201-T	1206-T	1208-T	1204-T	1205-T
		Trasparente - Transparent - Transparent - Transparent - Transparente				
1200-TB	1209-TB	1201-TB	1206-TB	1208-TB		1205-TB
		Blu trasparente - Transparent blue - Bleu transparent - Blau transparent - Azul transparente				
27 x 35 x H 6 cm	35 x 27 x H 6 cm	H 9 cm	38 x 15 x H 6 cm	8,5 x 9,5 x H 9 cm	8,5 x H 11 cm	ø 4,5 x H 13 cm



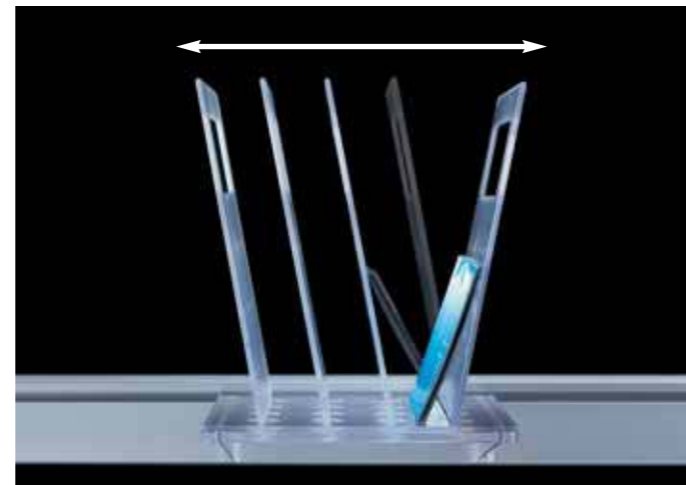

I→Innovativo pianetto brevettato che può essere attrezzato con appositi separatori inclinabili per contenere buste o fogli. I separatori possono essere montati frontalmente o lateralmente. Sia il pianetto che i separatori sono realizzati in policarbonato. GB→Innovative, patented shelf that can be combined with special, reclining separators for envelopes or sheets of paper. The separators may be mounted in front or laterally. Both shelf and separators are in polycarbonate. F→Tablette innovante brevetée que peut être équipée de séparateurs spéciaux inclinables pour enveloppes ou feuilles. Les séparateurs sont montés de front ou latéralement. Le tablette et les séparateurs sont réalisés en polycarbonate. D→Innovatives patentiertes Regal, die mit speziellen schrägstellbaren Trennern für Kuverts oder Blätter ausgestattet werden können. Die Trenner können frontal oder seitlich montiert werden. Sowohl die Regale als auch die Trenner sind aus Polycarbonat. E→Innovadora repisa patentada que puede equiparse con unos separadores inclinables para sujetar hojas o sobres. Los separadores pueden montarse en la parte delantera o en los laterales. Tanto la superficie como los separadores son de policarbonato.

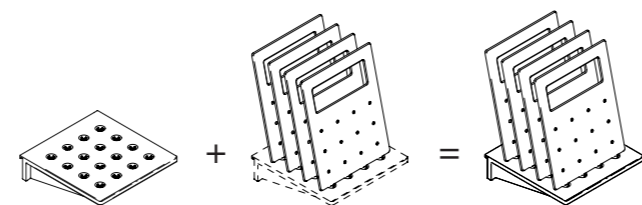

1212-T
24 x 25 x H 6 cm

1213-T
21,5 x H 27 cm

1214-T
24 x 25 x H 33 cm





I→Gli accessori da scrivania Desk Up sono stati sottoposti a prove di resistenza ai carichi e di flessione messe a punto dall'azienda stessa in collaborazione con i laboratori di prova (CATAS). Gli elementi Desk Up sono stati testati ipotizzando e simulando gravose condizioni di utilizzo per garantire prestazioni elevate. **GB**→The desk set Desk Up underwent load and flexion resistance tests set up by the company together with the test labs (CATAS). Desk Up units were tested by simulating heavy conditions of use to assure high performance. **F**→Les accessoires de bureau Desk Up ont été soumis à essais de résistance aux charges et flexion mis au point par la maison en collaboration avec les laboratoires d'essai (CATAS). Les éléments Desk Up ont été testés en supposant et simulant des conditions lourdes pour garantir des performances élevées. **D**→Das Schreibtischzubehör Desk Up wurde durch Resistenztest auf Belastungen und Biegungen geprüft, die vom Unternehmen selbst mit den Prüflabors (CATAS) ausgearbeitet wurden. Die Elemente Desk Up wurden unter Annahme und bei Simulation von schwierigen Benutzungsbedingungen getestet, um hohe Leistungen zu gewährleisten. **E**→Los accesorios de escritorio Desk Up se han sometido a pruebas de resistencia a las cargas y de flexión realizadas por la misma empresa en colaboración con los laboratorios de prueba (CATAS). Los elementos Desk Up se han testado con hipótesis y simulaciones de difíciles condiciones de uso para garantizar altas prestaciones.

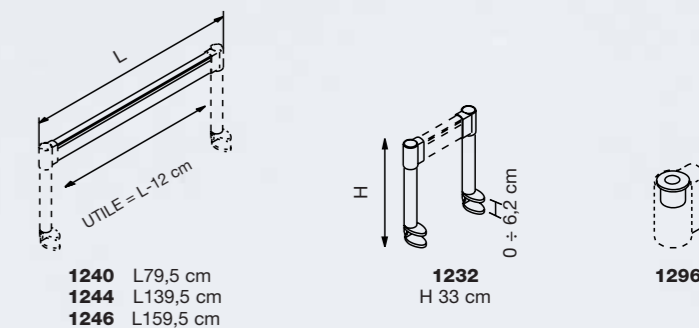
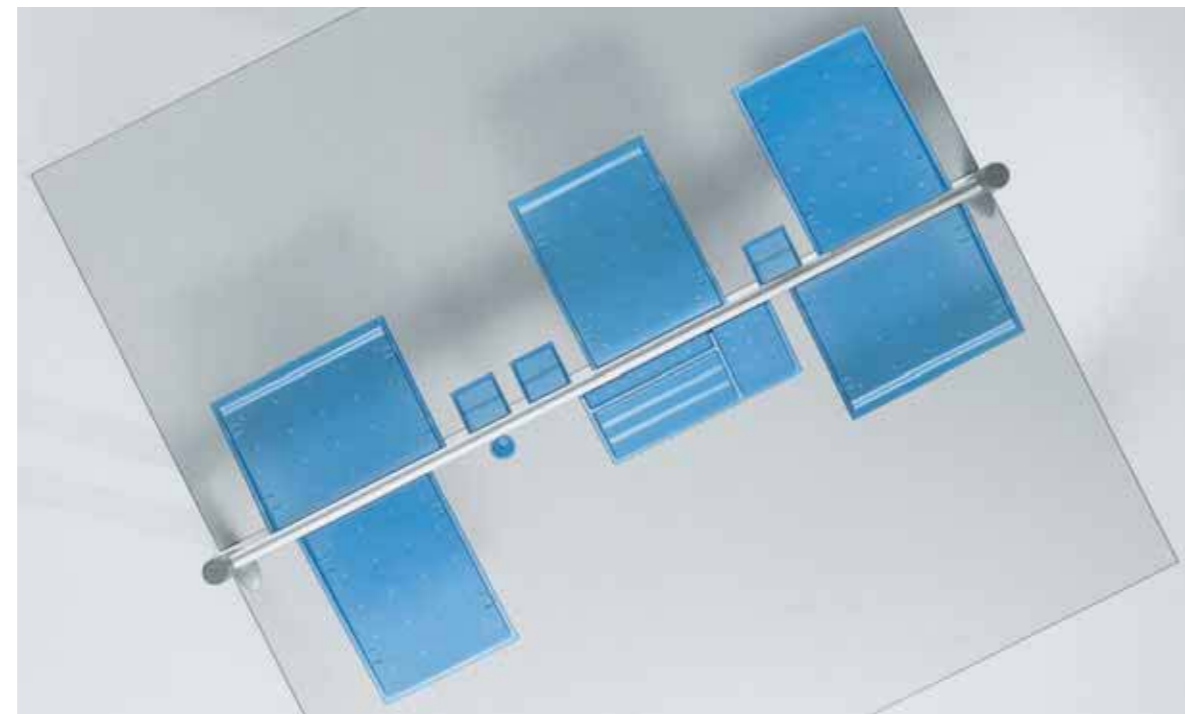

I→Colonne portanti realizzate in acciaio verniciato con polveri epossidiche antigraffio e antiriflesso. Disponibili con altezza 33 cm. **GB**→Load-bearing columns in steel with a scratchproof, anti-glare epoxy painted finish. Available in height of 33 cm. **F**→Les colonnes de soutien réalisées en acier et peint en époxy antirayures et antireflet sont disponibles dans la hauteur 33 cm. **D**→Die Stahltragsäule ist in der Version 33 cm hoch lieferbar und kratzfest, reflexionsfrei bepulvert. **E**→Columnas portantes realizadas en acero pintado con polvos epoxi antirayaduras y antirreflejo. Disponibles con altura de 33 cm.



I→Desk Up è un innovativo sistema brevettato che permette di sviluppare verticalmente la scrivania, liberando completamente il piano di lavoro. L'attento studio ergonomico e il design essenziale permettono a Desk Up di attrezzare qualsiasi scrivania fondendosi con gli elementi d'arredo esistenti e ottimizzando lo spazio con un minimo investimento. **GB**→Desk Up is an innovative, patented system which enables the desk to be developed vertically so that the work surface is completely free. With its attentive ergonomic design and straight forward look, Desk Up can harmonise with existing furnishings and optimise space on any type of desk with a minimal investment. **F**→Desk Up est un système innovateur breveté qui permet d'organiser le bureau verticalement, libérant ainsi le plan de travail. L'étude ergonomique soignée et le design essentiel permettent à Desk Up d'équiper toute table de bureau, en optimisant l'espace et cela avec un investissement minimum. **D**→Desk Up ist ein innovatives, patentiertes System zur Nachrüstung des Schreibtisches mit Organisationsmitteln, Tischwänden und Ablagen. Ergonomie und Design sind die Grundziele des Systems, das zur Arbeitseffizienz und zur ästhetischen Renovierung des Schreibtisches in jedes Büro mit geringen Investitionen eingesetzt werden kann. **E**→Desk Up es un sistema innovativo patentado que permite desarrollar verticalmente el escritorio, liberando completamente el plano de trabajo. El atento estudio ergonómico y el especial diseño permiten a Desk Up de equipar cualquier escritorio fundiéndose con los elementos de decoración existentes y optimizando el espacio con una inversión mínima.



Hi-tech

I → Sottomano in espanso nero. **GB** → Desk pad in black plastic foam. **F** → Sous-main en expansé noir.
D → Schreibunterlage aus schwarzem Kunststoff.
E → Carpeta en material expandido negro.

1463
50 x 35 cm
1463-M
60 x 40 cm



417-GA
ø 25 x H 32 cm



1628-GA
38 x 27 x H 6,5 cm



1626-GA
31 x 8,5 x H 6,5 cm



1625-GA
ø 20 x H 3,3 cm



1627-GA
ø 8,5 x H 8,5 cm

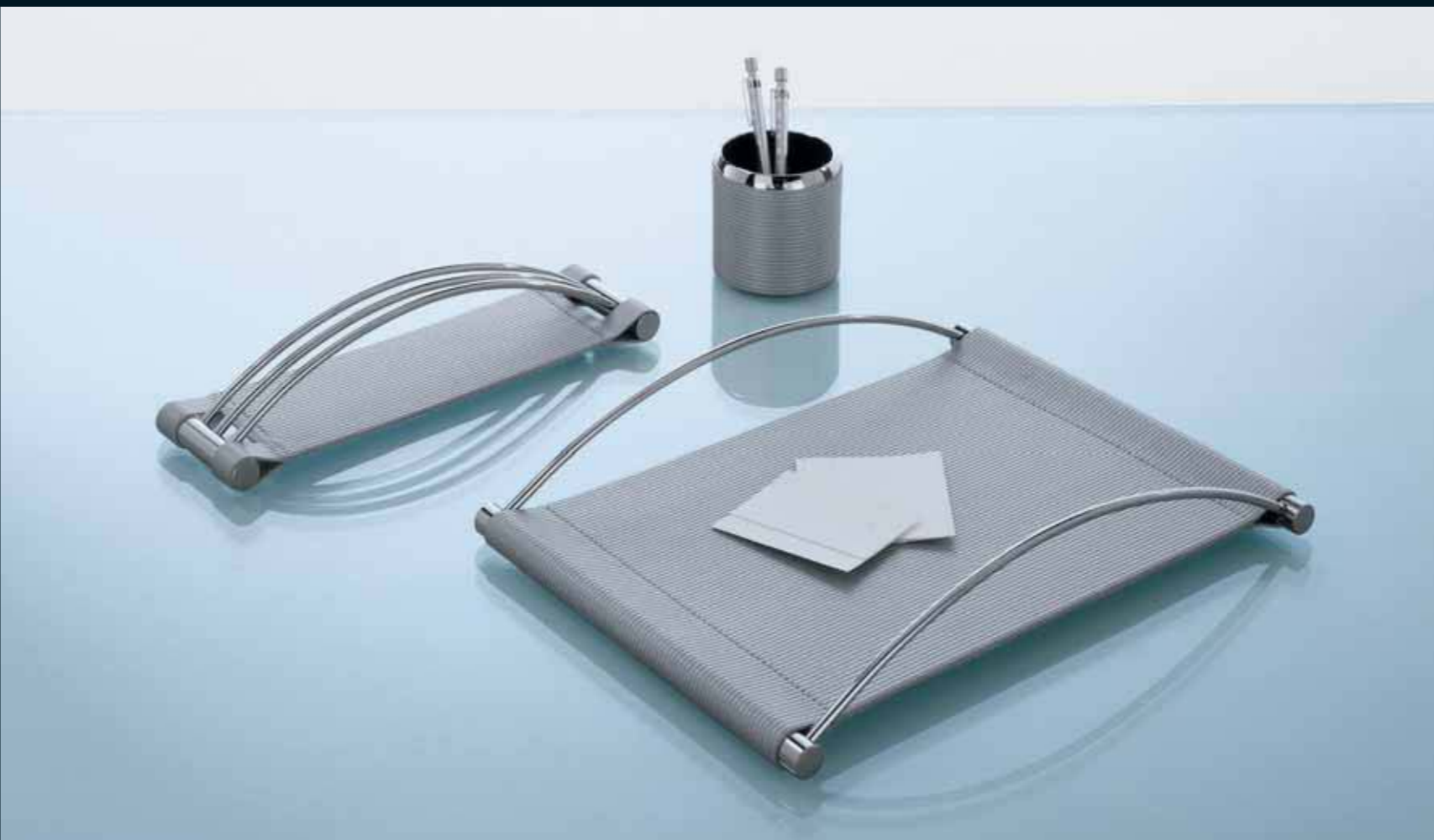

I → Linea direzionale di accessori per scrivania realizzati in espanso rigato grigio con particolari in acciaio cromato. **GB** → Executive line of desk accessories in grey ribbed plastic foam with parts in chrome-plated steel. **F** → Gamme d'accessoires pour bureau de direction réalisée en expansé rayé gris avec détails en acier chromé. **D** → Exklusives Programm von Schreibtischzubehör aus mit grau farbigem gerilltem Kunststoffschäum mit Beschlägen aus verchromtem Stahl. **E** → Línea de dirección de accesorios para escritorio realizados en material expandido rayado gris con detalles en acero cromado.



1629
60 x 40 cm



417
ø 25 x H 32 cm



1630
60 x 40 cm



1627
ø 8,5 x H 8,5 cm



1625
ø 20 x H 3,3 cm



1633
13 x 7,5 x H 3 cm



1623
22,5 cm



1626
31 x 8,5 x H 6,5 cm



1631
25 x 35 cm



1632
25 x 35 x H 3 cm

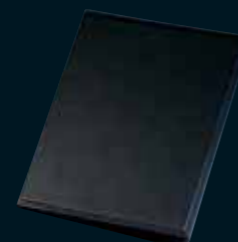

1631
25 x 35 cm

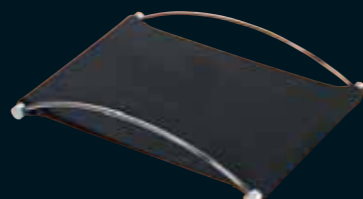

1628
38 x 27 x H 6,5 cm



I→Il connubio ecopelle-metallo cromato e la cura del dettaglio rendono Master una linea di accessori eleganti indirizzati all'ufficio direzionale. Tutte le parti in ecopelle sono lavorate artigianalmente, il bordo viene lucidato ed impreziosito da un'impuntura a mano tono su tono. GB→The use of chrome-plated metal and imitation leather and the careful details make Master a line of elegant fittings meant for the executive office. All parts in imitation leather are hand-worked, the edge is polished and enhanced by a tone-on-tone stitching. F→L'union éco-cuir et métal chromé et le soin du détail rendent Master une gamme d'accessoires élégants conçus pour le bureau de direction. Toutes les parties en éco-cuir sont travaillées à la main, le bord est ciré et enrichi d'un point piqué ton-sur-ton. D→Die Verbindung Kunstleder - verchromtes Metall und die Aufmerksamkeit auf das Detail machen Master zu einer eleganten Zubehörlinie, die für das Direktionsbüro gedacht ist. Alle Teile aus Kunstleder sind handwerklich angefertigt, der Rand wird poliert und Ton auf Ton gesteppt. E→La unión ecopiel-metal cromado y el cuidado del detalle convierten a Master en una línea de elegantes accesorios dirigidos a la oficina direccional. Todas las piezas de ecopiel se elaboran artesanalmente, el borde se pule y se embellece con un pespunte a mano sobre tono.





1656-EN
30 x 12,5 x H 7,5 cm

1658-EN
29,5 x 36 x H 5,5 cm



1657-EN
ø 8 x H 9,5 cm

1659-EN
60 x 45 x H 3 cm

I→Le morbide curve disegnate da Iacchetti+Ragni per Ikarus sono realizzate grazie all'accoppiamento della pelle rigenerata con un'anima in metallo sagomata. Tutti gli oggetti sono rifiniti con bordi lucidati ed impunturati tono su tono e impreziositi da piedini e dettagli in acciaio satinato. GB→The soft curves designed by Iacchetti+Ragni for Ikarus are carried out through the use of regenerated leather and a shaped metal core. All objects are finished with polished and tone-on-tone stitched edges and enhanced by feet and parts in mat steel. F→Les courbes souples dessinées par Iacchetti+Ragni pour Ikarus, sont réalisées en utilisant le cuir régénéré avec un noyau en métal façonné. Tous les objets ont les bords cirés et au point piqué ton-sur-ton et enrichis de pieds et détails en acier mat. D→Die von Iacchetti+Ragni für Ikarus gezeichneten weichen Kurven wurde dank des Regeneratleders, das durch einen Kern aus geformtem Metall belebt wird, hergestellt. Alle Gegenstände sind mit polierten Rändern, Ton auf Ton gesteppt und durch Füßchen und Details aus satiniertem Stahl aufgewertet. E→Las suaves curvas diseñadas por Iacchetti+Ragni para Ikarus, están realizadas gracias a la combinación de la piel regenerada con un alma de metal perfilada. Todos los objetos se acaban con bordes pulidos, respunteados tono sobre tono y embellecidos con pies y detalles de acero satinado.





1472-ECO
ø 40 x 5 cm

I→Orologio in fibra di legno riciclata e polipropilene. Numeri in tecnopolimero laccato e lancette in alluminio. L'orologio è caratterizzato dalle ore in rilievo che conferiscono un particolare effetto tridimensionale, creando un gioco di luci e di ombre. Un orologio "ecologico" che permette un utilizzo intelligente del materiale riciclato, riducendo l'uso di materie prime, contribuendo alla salvaguardia dell'ambiente. **GB**→Clock in recycled wood fibre and polypropylene. Numbers in enamelled high-tech polymer and aluminium hands. It features raised hours, that produce a special three-dimensional effect and create a play of lights and shades. An "eco-friendly" clock allowing a clever use of the recycled material, reducing the use of raw materials, thus helping to environmental protection. **F**→Horloge en fibre de bois recyclée et polypropylène. Nombres en technopolymère laqué et aiguilles en aluminium. L'horloge est caractérisé par les heures en relief qui donnent un effet spécial tridimensionnel, créant un jeu de lumières et ombres. Un horloge "écologique" qui permet un emploi intelligent du matériel recyclé, réduisant l'usage de matières premières, contribuant ainsi à la sauvegarde du milieu. **D**→Uhr aus recycelter Holzfaser und Polypropylen. Zahlen aus lackiertem Technopolymer und Zeiger aus Aluminium. Die Uhr charakterisiert sich durch angehobene Stunden, die einen besonderen dreidimensionalen Effekt verleihen und ein Spiel von Licht und Schatten erzeugen. Eine "umweltbewusste" Uhr, die eine intelligente Nutzung von recyceltem Material ermöglicht und die Verwendung von Rohstoffen verringert, wodurch sie zum Umweltschutz beiträgt. **E**→Reloj de fibra de madera reciclada y polipropileno. Números de tecnopolimero lacado y agujas de aluminio. El reloj está caracterizado por tener las horas en relieve que proporcionan un efecto tridimensional especial, creando un juego de luces y sombras. Un reloj "ecológico" que permite un uso inteligente del material reciclado, reduciendo el uso de materias primas y contribuyendo a la protección del medio ambiente.



1472-NBR
ø 40 x 5 cm



1472-BN
ø 40 x 5 cm



1472-NB
ø 40 x 5 cm



1472-GA
ø 40 x 5 cm

I→Orologio in tecnopolimero laccato con lancette in alluminio. L'orologio è caratterizzato dalle ore in rilievo che conferiscono un particolare effetto tridimensionale, creando un gioco di luci e di ombre. **GB**→Clock in enamelled high-tech polymer with aluminium hands. It features raised hours, that produce a special three-dimensional effect and create a play of lights and shades. **F**→Horloge en technopolymère laqué avec aiguilles en aluminium. L'horloge est caractérisé par les heures en relief qui donnent un effet spécial tridimensionnel, créant un jeu de lumières et ombres. **D**→Uhr aus Technopolymer, lackiert mit Aluminiumzeigern. Die Uhr charakterisiert sich durch angehobene Stunden, die einen besonderen dreidimensionalen Effekt verleihen und ein Spiel von Licht und Schatten erzeugen. **E**→Reloj de tecnopolimero lacado con agujas de aluminio. Está caracterizado por tener las horas en relieve lo que proporciona un efecto tridimensional especial, creando un juego de luces y sombras.



Witteveen Projectinrichting
 Ouderkerk a/d Amstel
 Tel: 020 - 496 5030
 Fax: 020 - 496 3052
 info@witteveen.nl
 www.project-inrichting.nl



545-GA
 37 x 21 x H 44 cm

Stil

I→Portariviste in acciaio verniciato con polveri epossidiche ed espanso rigato grigio argento.
 GB→Magazine rack in powder-coated steel and silver grey ribbed plastic foam.
 F→Porte-revues en acier peint en époxy et expansé rayé gris argenté.
 D→Zeitschriftenständer aus mit Epoxypulvern beschichtetem Stahl und geripptem, silbergrau Kunststoff.
 E→Revistero en acero pintado con polvos epoxi y material expandido rayado gris plata.

Marie Antoinette

I→Candelabro in acciaio verniciato con polveri epossidiche.
 GB→Candelabrum in powder-coated steel.
 F→Candélabre en acier peint époxy.
 D→Kerzenständer aus mit Epoxidpulver beschichtetem Stahl.
 E→Candelabro de acero recubierto con polvo epoxi.

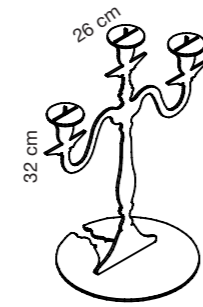

1423-BO
 ø 16 cm

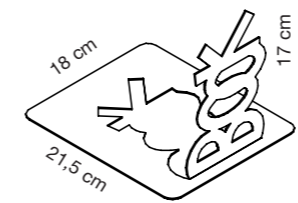

1421-BO

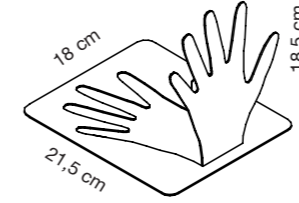

1420-BO

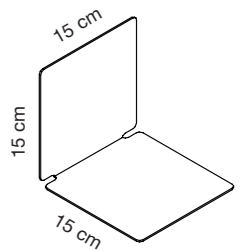

5987-GA
 5987-BO
 5987-N



Stopper: Design Sezgin Aksu, Silvia Suardi



Big: Design Marc Sadler

I→Fermalibri in acciaio verniciato con polveri epossidiche. GB→Book end in powder-coated steel. F→Serre-livres en acier peint en époxy. D→Bücherstütze aus mit Epoxidpulver beschichtetem Stahl. E→Sujetalibros de acero recubierto con polvo epoxi.